



# SACF 25<sup>®</sup> Semi-Automatic Capsule Filler User Manual



We don't just sell machines—  
we provide service.

# Copyright Notice

© LFA Machines Oxford Limited, published in 2025 by LFA Machines Oxford Limited 2022. Registered in England and Wales, company number 08428898, registered office for service Demar House 14 Church Road East Wittering, Chichester, West Sussex, PO20 8PS.

All rights reserved. No part of this publication may be reproduced or transmitted, in any form or by any means, or stored in any retrieval system of any nature, without prior permission, except for fair dealing under the Copyright, Designs and Patents Act 1988, or in accordance with the terms of license issued by the Copyright Licensing Agency in respect of photocopying and/or reprographic reproduction. Application for permission for other use of the copyright material including permission to reproduce extracts in other published works shall be made to the publisher. Full acknowledgment of author, publisher and source must be given.

All trade marks are acknowledged and are owned by their respective owners.

# Important Safety Information

## READ THIS BEFORE OPERATING MACHINE

### Intended Use

The intended use of this machine is to fill empty capsules with dry raw materials.

Potential misuse of this machine includes:

- Using any capsules that deviate from the standard two-piece design.
- Using softgel capsules.
- Using powders that could explode under pressure.
- Using wet or damp material.

### Personal Protection

For personal protection while transporting the SACF 25<sup>®</sup>, abide by these actions:

- Use a pallet jack to lift the machine.
- Wear steel toe boots to prevent foot injury.
- Wear heavy duty grip gloves to ensure firm grasp on machine.
- Wear back support belt to prevent injury if needed.

For personal protection while operating the SACF 25<sup>®</sup>, abide by these actions:

- Avoid wearing loose jewelry to prevent machine entanglement.
- Contain long hair to prevent machine entanglement.
- Wear safety goggles.
- Wear disposable latex/rubber gloves.
- Wear a hairnet (food grade products only).
- Wear a beard net if needed (food grade products only).

### General Hazards

**In the case of an emergency during operation, immediately push the Emergency Stop button.**

- Do not allow powder to collect at the turntables.
- Be aware of risk of entanglement and pinch point due to moving parts.
- Do not operate in a wet environment or with wet hands due to risk of electrical shock or burn.
- Do not operate if any wires are exposed in cables due to risk of electrical shock or burn.
- Use extreme caution when servicing any electrical component.
- Keep out of reach from children.
- Keep fingers away from all moving parts.
- Inspect machine before use.
- Check that nuts and bolts are suitably tightened.
- Use this machine only for its intended use as described in this manual.
- Do not modify the machine in any way.
- Turn off and unplug the machine before conducting cleaning and maintenance.

### Safety Assessment

It is critical to conduct a safety assessment to ensure that it complies with all local laws and industry accepted safety regulations.

If you require guidance on the installation of the machine or conducting a safety assessment, please contact LFA Machines.

# Important Safety Information

## READ THIS BEFORE OPERATING MACHINE

### Symbols



#### WARNING

This signals potential risk for personal injury.



#### WARNING

This signals potential risk for electrical shock.



#### CAUTION

This signals potential risk for damage to the machine or other parts.

### Modes for Stopping

In the case of an emergency during operation, immediately push the Emergency Stop button and unplug the SACF 25®:



### Prop. 65 Statement for CA Residents

Based on LFA's current level of knowledge of our machines, the SACF® does not require a Proposition 65 warning label.

### Warning for Explosive Material

This machine is not explosion proof. LFA recommends that you test your materials' explosivity before running them through this machine. If your materials are indeed explosive, do not use them with this machine.

# Table of Contents

<b>Copyright Notice</b>	<b>2</b>
<b>Important Safety Information</b>	<b>3</b>
Intended Use	3
Personal Protection	3
General Hazards	3
Safety Assessment	3
Symbols	4
Modes for Stopping	4
Prop. 65 Statement for CA Residents	4
Warning for Explosive Material	4
<b>SACF 25<sup>®</sup> Components</b>	<b>6</b>
<b>Preface</b>	<b>7</b>
<b>Training</b>	<b>8</b>
On-Site/Off-Site Training	8
Training via Video Chat/Phone	8
LFA Articles	8
LFA Videos	8
<b>Installation</b>	<b>9</b>
Tools and Materials Needed	9
Positioning the SACF 25 <sup>®</sup>	14
Controls	18
Settings and Adjustment	26
<b>Maintenance</b>	<b>35</b>
General Maintenance Prescriptions	35
Lubrication	35
Dismantling for Repair and Replacement	40
Wear Parts and Causes of Damage	41
<b>Troubleshooting</b>	<b>67</b>
Common Issues	67
Common Issues Continued	68
Common Issues Continued	69
De-Jamming the SACF 25 <sup>®</sup>	70
Cleaning	72
Storing the SACF	75
<b>Appendix</b>	<b>78</b>
Glossary	78
Description of SACF 25 <sup>®</sup> Parts	79
Food Grade Point of Contact Parts	81
Technical Specifications	81
Bores per Capsule Disc	81
Maintenance Checklist	82
Diagrams	83
Resources	87

# SACF 25<sup>®</sup> Components

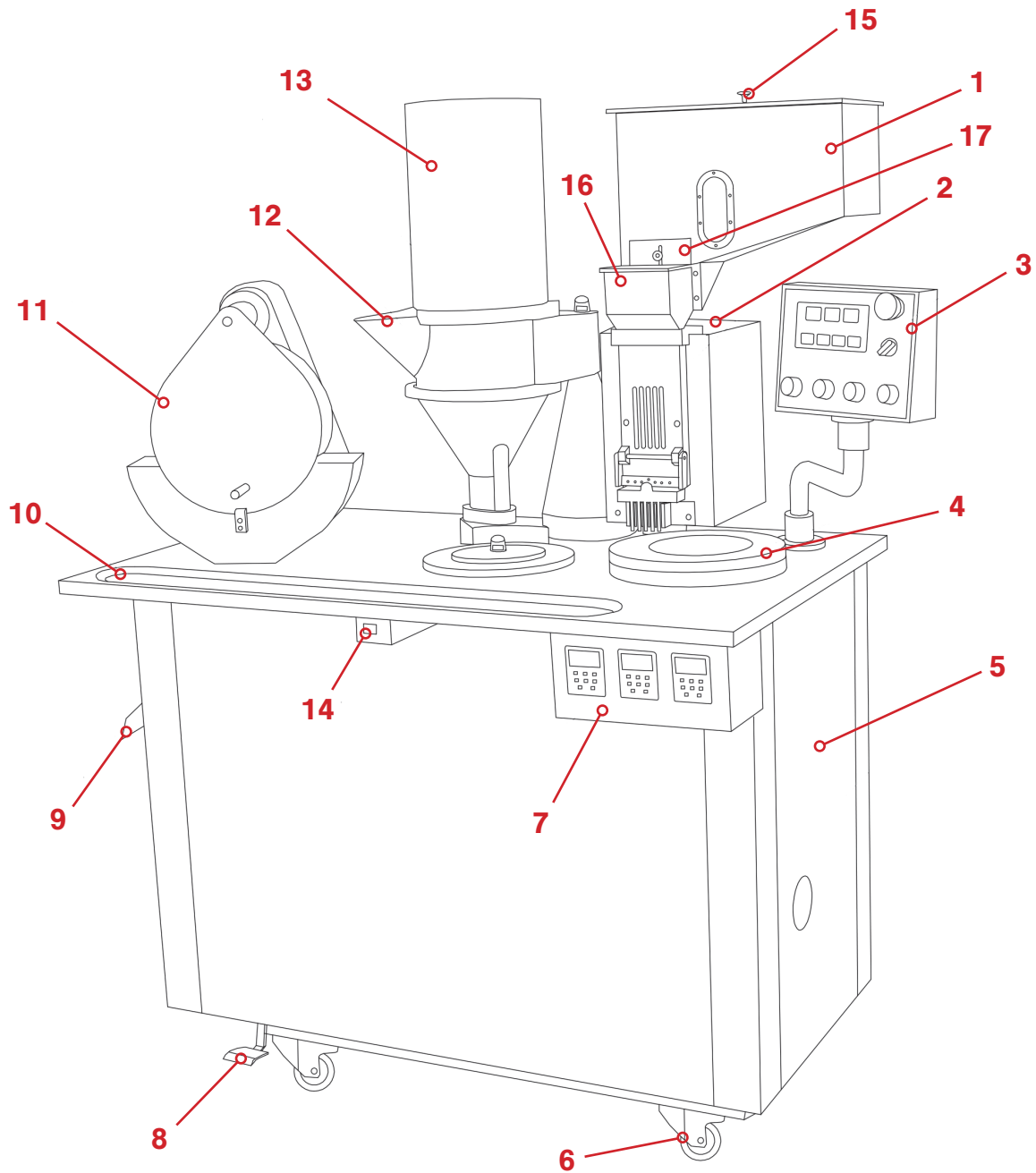

- |                                     |                                  |
|-------------------------------------|----------------------------------|
| 1. Capsule Hopper                   | 11. Capsule Sealing Plate        |
| 2. Capsule Sewing Mechanism         | 12. Powder Hopper                |
| 3. Control Panel                    | 13. Auger Housing                |
| 4. Capsule Discs                    | 14. Capsule Filling Start Button |
| 5. Base                             | 15. Capsule Hopper Lid           |
| 6. Wheel                            | 16. Capsule Sewing Repository    |
| 7. Variable Frequency Drives (VFDs) | 17. Capsule Hopper Gate          |
| 8. Capsule Sealing Pedal            |                                  |
| 9. Ejection Tray                    |                                  |
| 10. Excess Powder Collector         |                                  |

# Preface



The SACF 25<sup>®</sup> is a semi-automatic capsule filler that accurately and efficiently produces up to 25,000 capsules of varying sizes per hour. Able to fill capsules from #00 to #5, this low noise machine has an inbuilt vacuum system for loading and sealing capsules, giving greatly enhanced operator efficiency, and uses a corkscrew Auger mechanism to ensure accurate filling every time. Particularly popular in the pharmaceutical, food supplements, vitamins and minerals, food technology, veterinary and other industries, the SACF 25<sup>®</sup> has been designed for fast production with an emphasis on safety and ease of use.

The purpose of this document is to support your understanding of the SACF 25<sup>®</sup>'s components, features, functions, and design. With this manual, you will be able to successfully operate and maintain your SACF 25<sup>®</sup> machine.

The user manual's content includes:

- Important safety information
- SACF 25<sup>®</sup> installation instructions
- Description of the SACF 25<sup>®</sup>'s operation
- SACF 25<sup>®</sup> maintenance information
- Appendix with supplemental information

# Training

SACF 25<sup>®</sup> training is essential for the machine's successful operation and your personal safety. There are several methods to prepare you for working with the SACF 25<sup>®</sup>.

## On-Site/Off-Site Training

LFA technicians can travel and train you at your own facility with your own machines. LFA also offers free training at our UK, USA, and Taiwan facilities for all our customers and their teams. For more information, go to <https://www.lfacapsulefillers.com/services>

## Training via Video Chat/Phone

Using an online video chat system, an LFA technician can interact face-to-face with you and assist with your understanding of the machine. Or, if you prefer, LFA can provide training via phone for all customers who call the office. To set up a training, call or email your local LFA office:

### UK

**Phone**

+44 01869 250234

**Email**

[support.uk@lfamachines.com](mailto:support.uk@lfamachines.com)

### USA

**Phone**

+1 (682) 312-0034

**Email**

[support.usa@lfamachines.com](mailto:support.usa@lfamachines.com)

### Taiwan

**Phone**

+886 422031790

**Email**

[support.asia@lfamachines.com](mailto:support.asia@lfamachines.com)

## LFA Articles

LFA writes informative articles about capsules and capsule fillers, which includes instructions, procedures, and guides. To access the articles, go to <https://www.lfacapsulefillers.com/articles>

## LFA Videos

LFA has created several videos involving the SACF 25<sup>®</sup> and other capsule fillers. To access the videos, go to <https://www.lfacapsulefillers.com/videos> or <https://www.youtube.com/user/TabletPilPress>



# Installation

## Tools and Materials Needed

To watch a video of an SACF 25<sup>®</sup> setup, go to <https://www.lfacapsulefillers.com/sacf-setting-up>

Before you install and operate the SACF 25<sup>®</sup>, it is best to have the following tools and materials on hand for general operation and maintenance:

- Pallet jack
- Crowbar
- Hammer
- Socket wrench set
- Metric wrench set
- Crosshead screwdriver
- Flathead screwdriver
- Set of metric Allen keys with ball ends
- Long wire pipe cleaner
- Toothbrush
- Cleaner (e.g. Member's Mark Commercial Lemon Disinfectant)
- Sanitizer (e.g. Member's Mark Commercial Sanitizer)
- Lubricant (NSF approved type for food grade products)
- Vacuum pump motor oil
- Vacuum pump motor oil filter
- Empty container
- Permanent marker
- Cleaning brush/paintbrush
- Plastic sheet or something similar to cover machine
- Safety goggles
- Hairnet and/or beard net (food grade products only)
- Sterile shoe covers (food grade products only)

## The Appropriate Workstation for the Machine

The floor on which the machine is to be placed must support the SACF 25<sup>®</sup>'s 330 kg (about 727 lbs) weight. The static floor loading limit is 3.62 kN/m<sup>2</sup>.

The machine's motor requires a three-phase power supply of 440 V or 240 V. Ensure to position the machine near an appropriate electrical plug.

### Environmental Conditions

It is important that the environment in which you operate and store the SACF 25<sup>®</sup> has the appropriate temperature and relative humidity levels. These two environmental factors can potentially cause the machine to rust and/or cause the capsules to have a lower quality. The table below shows the acceptable temperature and relative humidity levels:

Machine	Temperature		Humidity
	°C	°F	
SACF 25 <sup>®</sup>	18-24	64-75	45-55% RH

The shipping crate will contain the following:

1. The SACF 25<sup>®</sup>



2. The Tooling (already installed)



### 3. Toolkit including:



- Toolbox
- Adjustable wrench
- Open-end wrenches
- Allen keys
- Needle-nose pliers
- Oil pot
- Flathead screwdriver
- Crosshead screwdriver
- Scraper
- Cover
- Pipe and tubing brushes
- Narrowing pickers
- Scoop
- Keys

### 4. Vacuum Pump and Filter



## Unpacking the SACF 25®

### Tools Needed

- Crowbar
- Hammer
- Socket wrench set

### Instructions

1. Pry open each side of the shipping container with a crowbar and hammer and remove them.



2. Remove the Filter, Vacuum Pump, Toolkit, and Power Cable.

2.1 Note: Be careful not to drop the heavy Vacuum Pump.

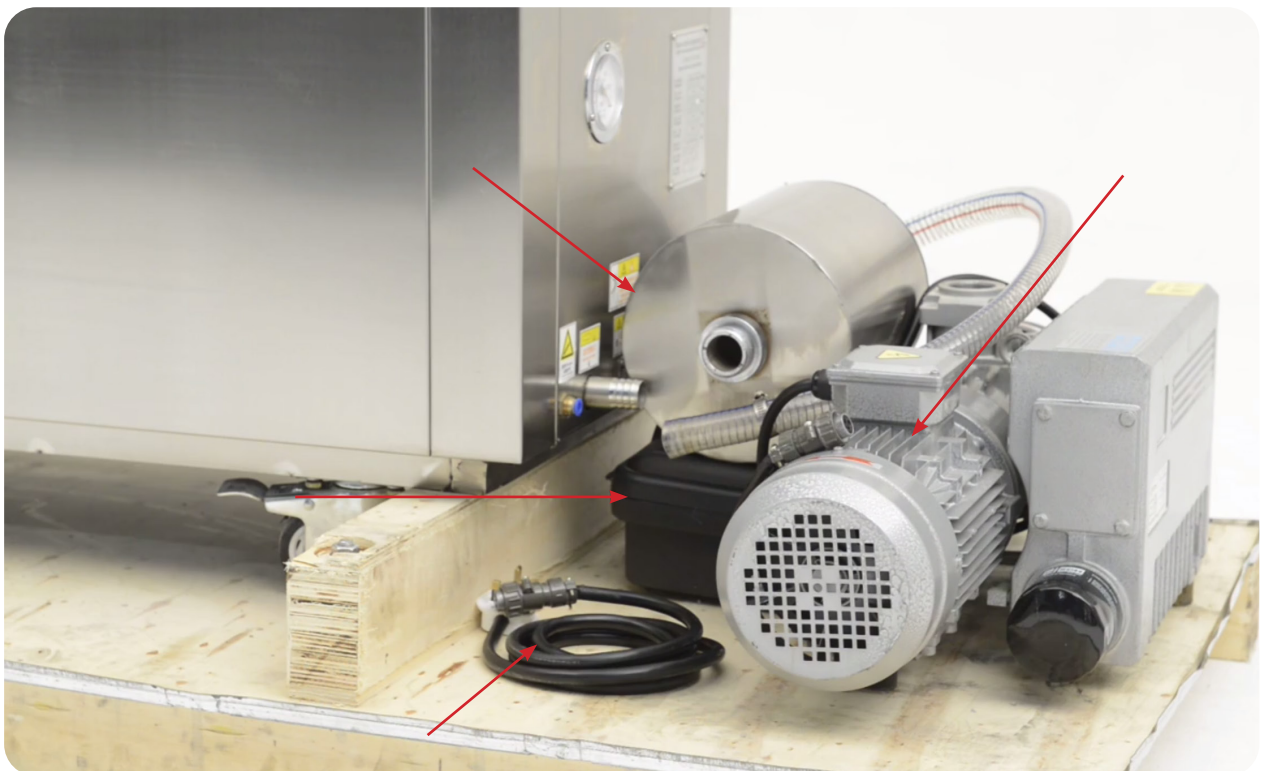

3. Remove the bolts on the shipping container's base with a socket wrench.

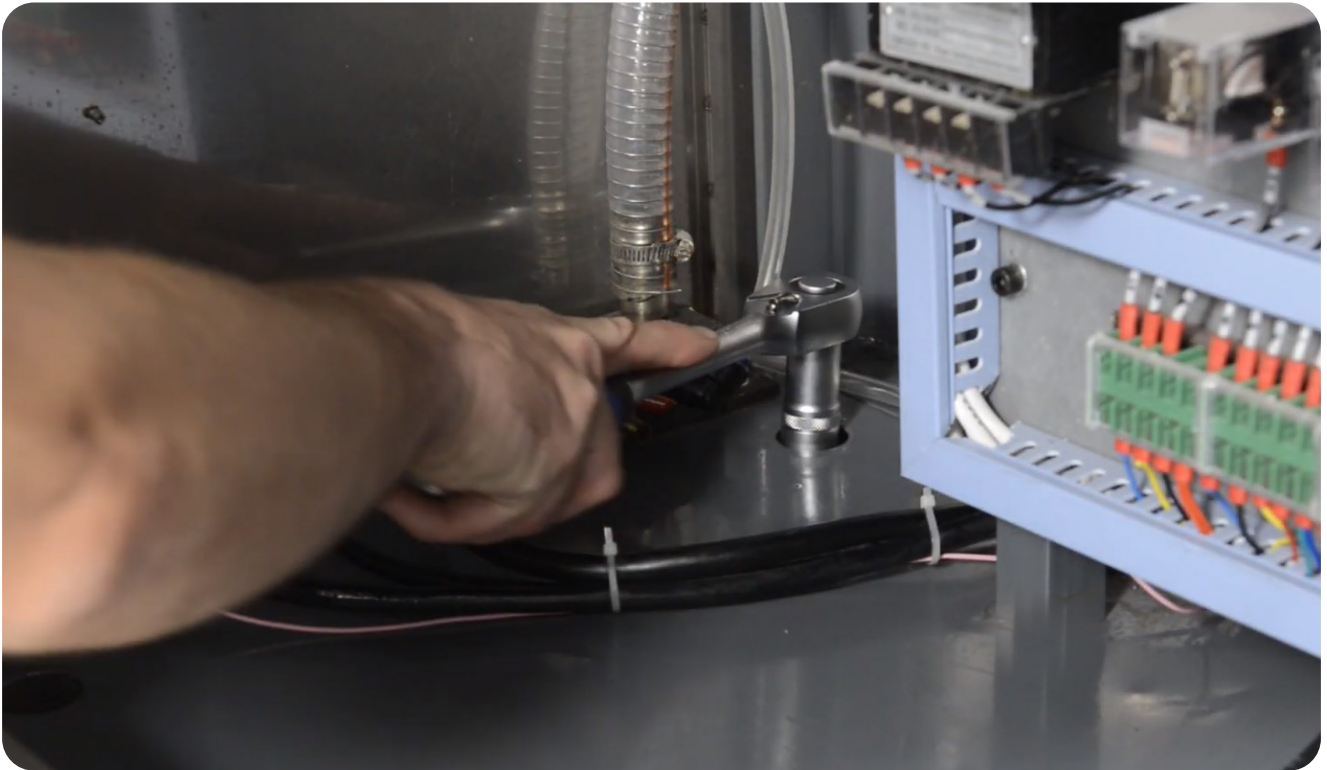

3.1 Note: Keep the nuts, bolts, and the shipping container's base in case you need to move or relocate the machine.

## Positioning the SACF 25<sup>®</sup>



**WARNING:** To prevent personal injury, wear steel toe boots and heavy duty grip gloves while transporting the SACF 25<sup>®</sup>.

Because of its 330 kg (around 727 lbs) weight, LFA does NOT recommend carrying the machine manually but rather with a pallet jack. At least two people should be involved (one operating the pallet jack and one stabilizing the machine) in removing the machine from the shipping container and placing it in the workspace.

### Moving the SACF 25<sup>®</sup> with a Pallet Jack

#### Tools Needed

- Wrench set
- Pallet jack
- Hammer
- Flathead screwdriver
- Heavy duty grip gloves
- Steel toe boots

#### Instructions

1. Remove the nuts from from the two woodblocks on the shipping container's base with a wrench.



2. Lift the shipping container's base with a pallet jack.

3. Use a flathead screwdriver and hammer to remove the bolts from the two woodblocks.



4. Place the pallet jack underneath the machine and lift it.

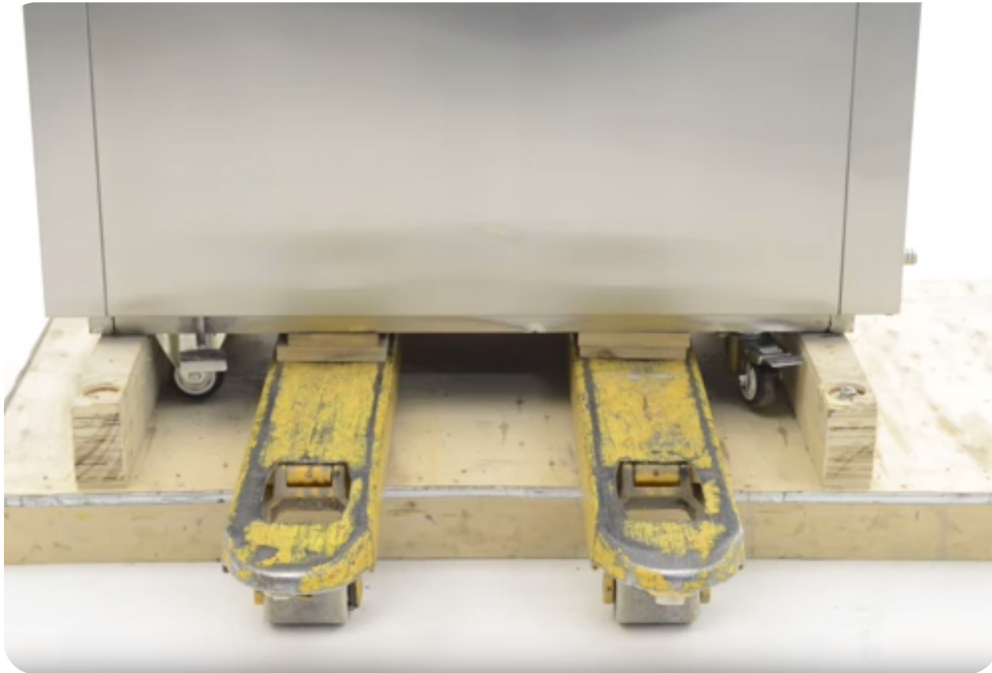

5. Remove the two woodblocks from the shipping container's base.

6. Pull out the shipping container's base from under the machine.

7. Carefully lower the pallet jack until the wheels make contact with the floor.



8. Unlock the machine's wheels and move it to the desired position.

8.1 Note: The machine's motor requires with a single-phase or three-phase power supply of 440 v/240 v. Ensure to position the machine near an appropriate electrical plug.

9. Lock the machine's wheels when it is set in place.

10. Place the Filter on top of the Vacuum Pump.

10.1 Note: Use plumber's tape around the threaded part of the Vacuum Pump to ensure a good seal to reduce pressure loss.

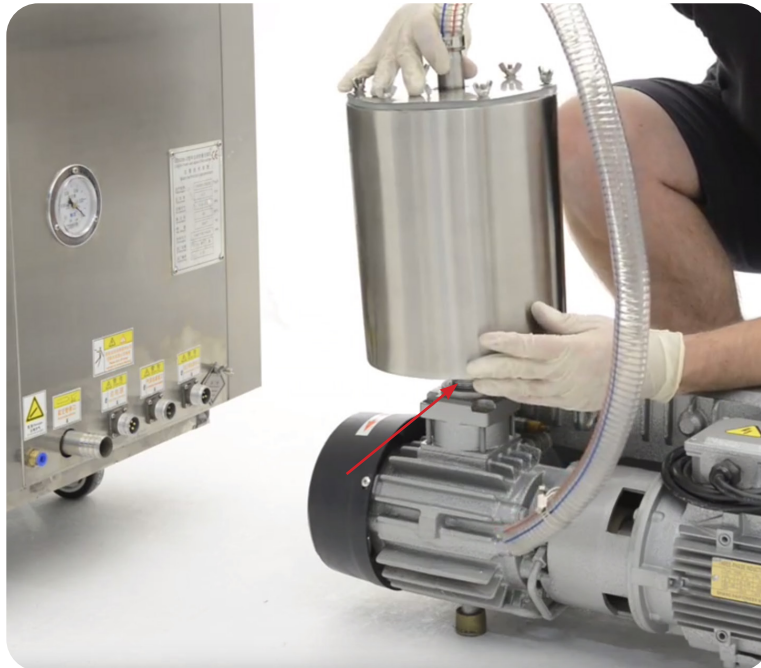

11. Plug in the Vacuum Compressor and main power cable.





12. Plug in the Vacuum Pump's hose and tighten it with a flathead screwdriver.

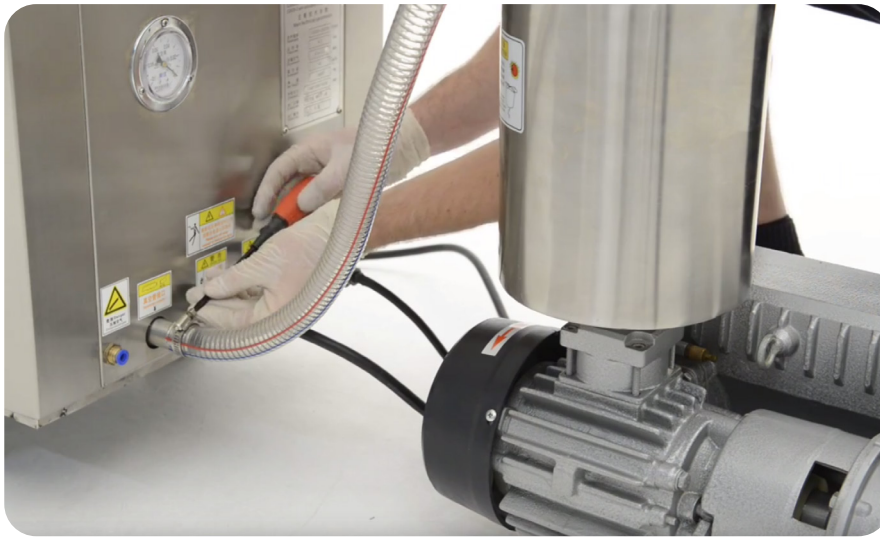

13. Insert the 8 mm push fit airline.



**WARNING:** To prevent against personal and machine injury, ensure that the machine is grounded before operating.



Be sure that the machine machine's frame is connected to ground by running a cable back to the socket or by attaching the machine to a grounding bar.

This will protect the machine from electrical shock, explosions, and the build up of static, which causes capsules to stick together.

# Controls

## Basic Components

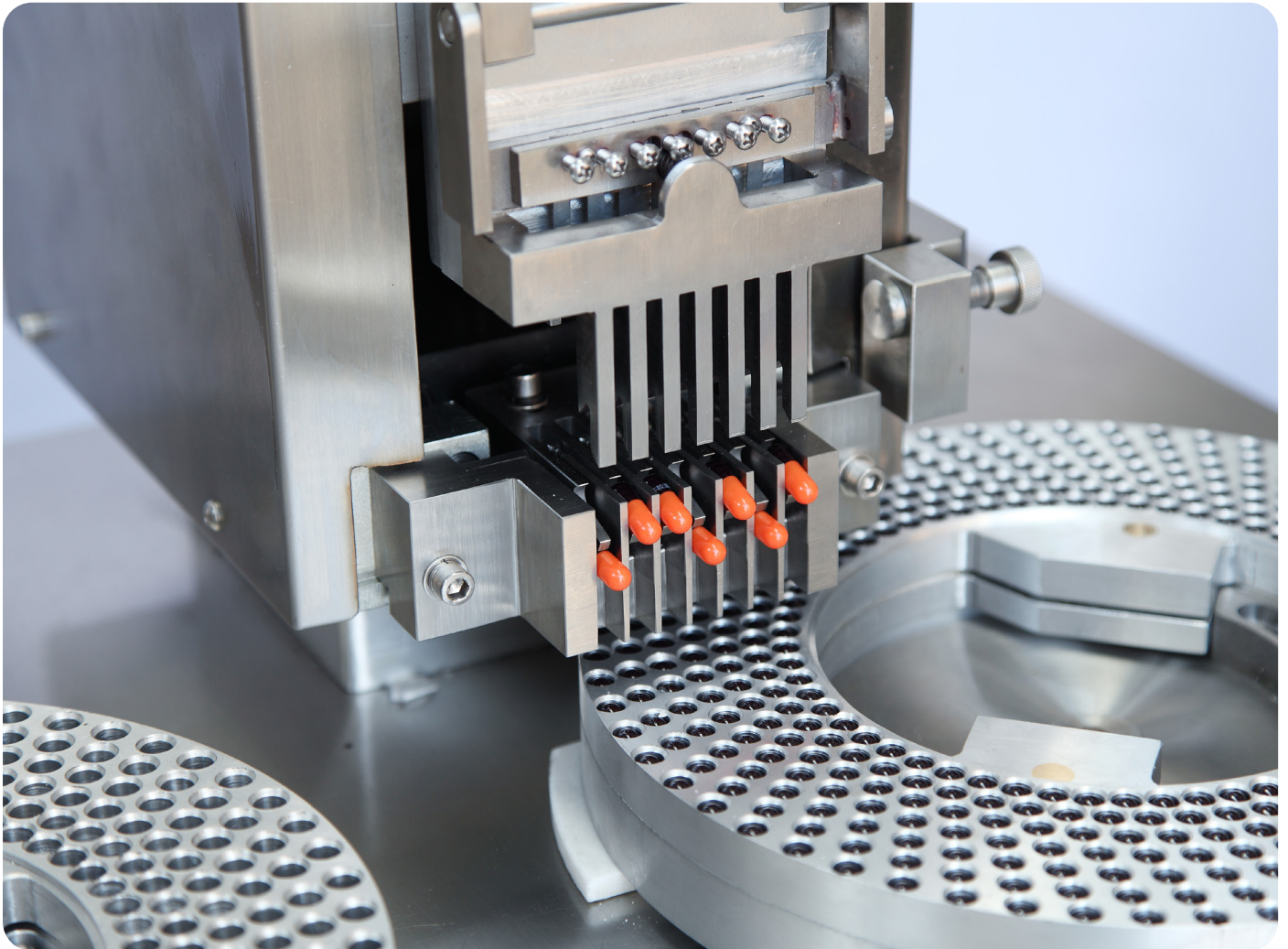

A description of the principal components follows:

- The **Capsule Hopper** holds the empty capsules.
- The **Capsule Sewing Mechanism** aligns the capsules in the correct position with a magazine and inserts them into the Capsule Discs, which separate the capsule caps and bodies with a vacuum pump.
- The **Powder Hopper** contains the mix that will be encapsulated.
- The **Auger** distributes the mix onto the Capsule Disc and into the capsule bodies.
- The **Capsule Sealer** compresses the capsule caps and bodies and ejects the filled capsules from the machine and into the chute.

## Control Console



1. Switch between Fill Count, Delay Filling, and Capsule Separating settings
2. Lower the setting
3. Raise the setting
4. Clear/set the adjustment

5. Switch from automatic mode to jog mode
6. Cut off machine in emergency
7. Operate the Auger and filling arm
8. Turn on/off the air pump
9. Operate the Capsule Sewer
10. Turn on/off the vacuum pump



1. Adjusts the speed of Capsule Disc's rotation during filling.
2. Adjusts the speed of the Auger's rotation.
3. Adjusts speed of Capsule Sewer.

## SACF 25® Process

The basic mechanism of the SACF 25® involves inserting the capsules into the Capsule Discs, separating the capsule halves, filling the capsule bodies, and sealing/ejecting the capsules.

### Inserting Capsules into the Tooling

Capsules are poured into the Capsule Hopper, which then distributes them to the Capsule Sewing Mechanism. The Capsule Magazine then orients the capsules in the correct position and sews them into the Capsule Discs. After the capsules' insertion, the vacuum pulls the capsule bodies from the caps. The operator then manually pulls apart the Capsule Discs, which each contain the capsule caps and bodies.

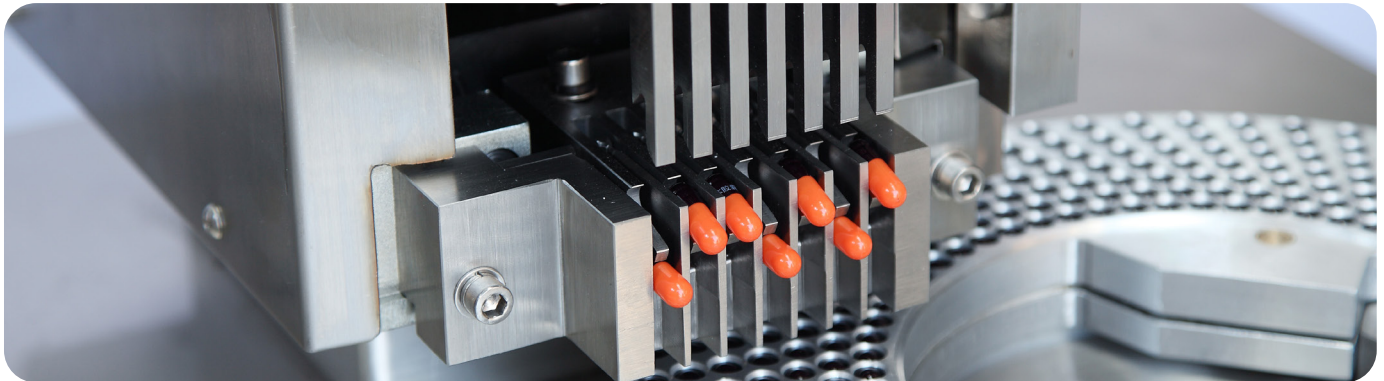

### Filling the Capsule Bodies with Powder

The disc with capsule bodies is inserted onto the turntable in front of the Powder Hopper. After the Powder Hopper is filled with dry materials, the Auger and filling arm evenly distributes the powder onto all the capsule bodies inside the plate.

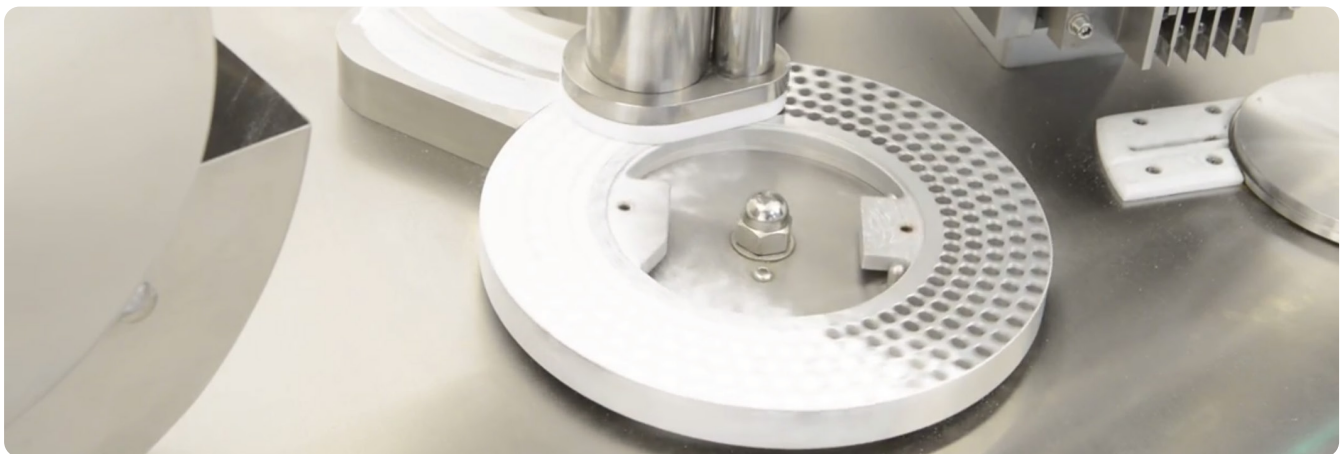

### Capsule Sealing and Ejection

After excess powder has been removed, both Capsule Discs are manually rejoined. The Capsule Discs are then inserted into the Capsule Sealer and pushed against the Capsule Ejection Disc, which adheres both halves of the capsules together and ejects the filled capsules from the plates.



## How to Fill Capsules with the SACF 25®

### Tools and Materials Needed

- Empty capsules
- Raw material formulation
- Fully assembled SACF 25®
- Powder scraper (comes with machine in SACF 25® Toolkit)
- Receptacle for filled capsules
- Safety goggles
- Disposable latex/rubber gloves (for food grade products and to protect hands from grease)
- Hairnet and/or beard net (food grade products only)
- Sterile shoe covers (food grade products only)

### Instructions

Note: Wear latex/rubber gloves (and appropriate food grade attire if applicable) during this process.

1. Place the receptacle for ejected capsules near the ejection chute.
2. Pour the empty capsules into the Capsule Hopper.
3. Loosen the nut and raise the gate to release the capsules into the Capsule Magazine.

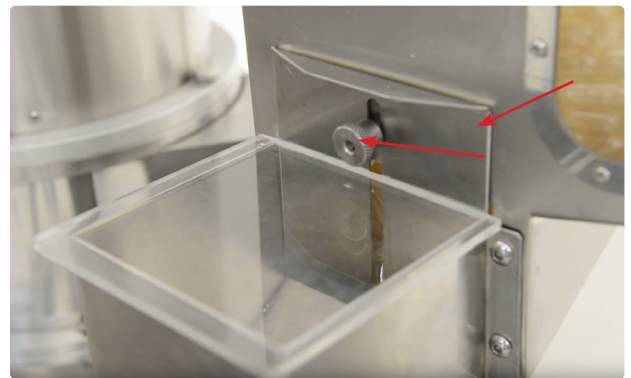

4. Place the Capsule Discs onto the turntable in front of the Capsule Sewer.  
4.1 Note: Ensure that the Capsule Discs are correctly positioned and turn clockwise.

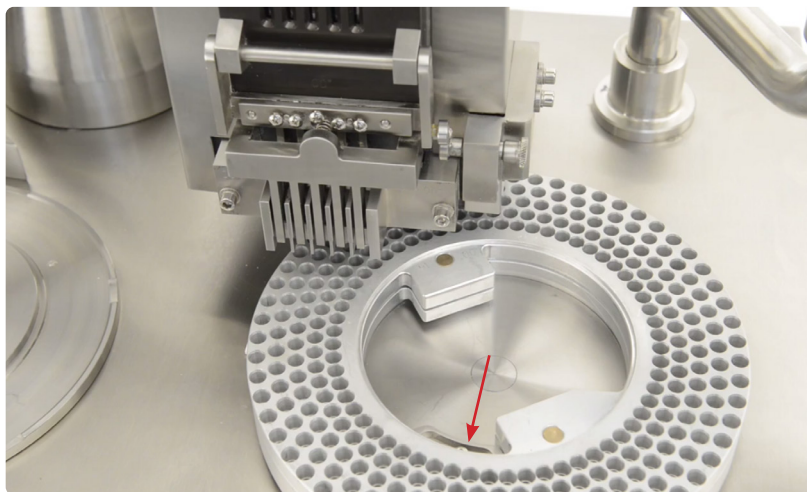

5. Press the Vacuum Pump button.
6. Press the Capsule Sewing button to insert the empty capsules into the Capsule Discs.



**WARNING:** To prevent any potential personal injury, keep hands and fingers away from the Capsule Sewer during operation.

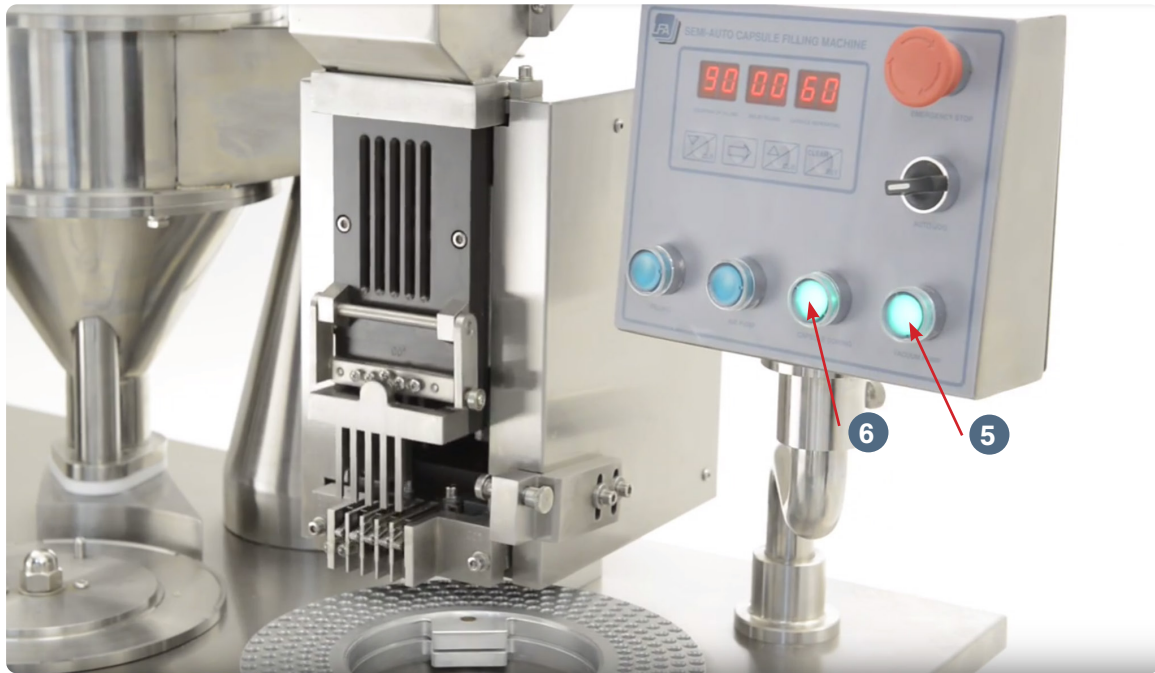

7. Rotate the Capsule Discs counterclockwise for a few rotations to ensure that the capsule caps and bodies are separated once the machine has finished automatically sewing the capsules.
8. Lift up the Capsule Discs from the turntable and place them on the turntable in front of the Auger.
9. Lift up the top Capsule Disc that contains the capsule caps and set aside.
  - 9.1 Note: Run a hand over each plate's surface to ensure that no capsule halves are sticking out.



10. Pour the dry materials into the Powder Hopper.



11. Press the Filling button to start the Auger.

11.1 Note: The Auger will automatically stop once it has filled each capsule body.



12. Remove the excess powder with the powder scraper.



13. Place the top Capsule Disc back onto the bottom one.



14. Align the Capsule Discs with the Capsule Ejection Disc and insert them on it.  
14.1 Note: Ensure that holes and pins are properly aligned.



15. Pull down the Capsule Ejection Disc's cover.

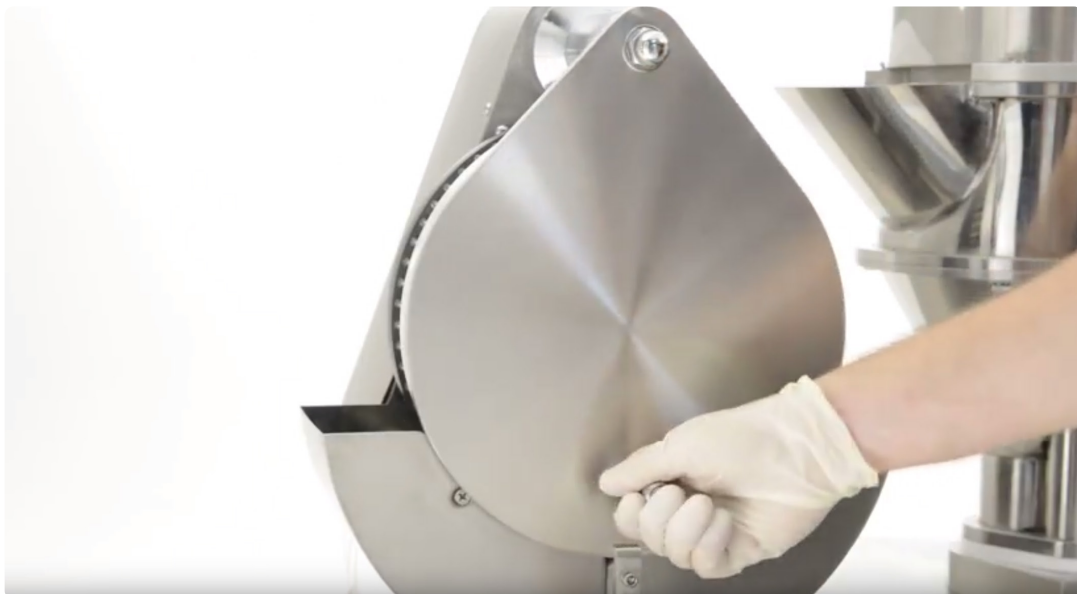



16. Press on the air pressure mechanism's food pedal to seal the filled capsules.

16.1 Note: The pedal is located at the bottom left of the machine.



17. Push the Capsule Discs against the Capsule Ejection Disc to eject the filled capsules.

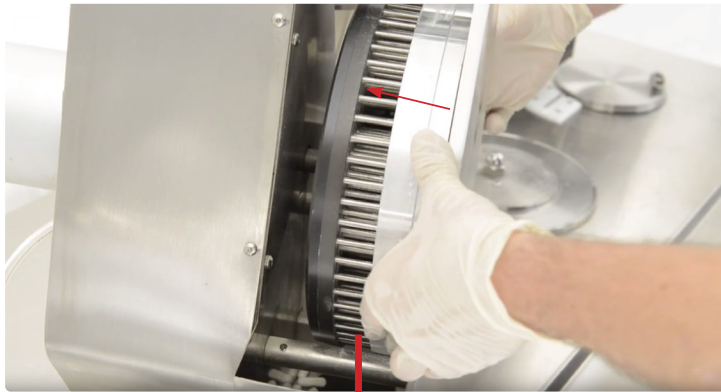

# Settings and Adjustment

The SACF 25®'s settings can be adjusted. Tuning the machine can help with changing the capsule dose and machine operation.

## Speed Adjustments

The SACF 25® has three variable frequency drivers (VFDs) for capsule sewing speed, auger speed, and capsule fill speed. These adjustments either lower or raise the following: the speed at which the capsules are inserted into the plates, the speed the Auger rotates, and the speed that powder fills the capsules.

### Tools and Materials Needed

- Disposable latex/rubber gloves (for food grade products and to protect hands from grease)
- Hairnet and/or beard net (food grade products only)
- Sterile shoe covers (food grade products only)

### Instructions

Note: Wear latex/rubber gloves (and appropriate food grade attire if applicable) during this process.

1. Run the Capsule Sewer and/or Auger for a few seconds to determine the adjustment.
2. Press the arrows to adjust the speeds.



Note the following:

- Capsule fill weight is increased as the turntable speed is decreased.
- Capsule fill weight is increased as the level of powder in the Powder Hopper is increased.
- Capsule fill rate is increased as the level of powder in the Powder Hopper is increased.

## Auger Fill Amount Time

Whenever the Capsule Disc's rotation speed is decreased, the Auger fill amount time has to be increased. This will make sure that there is enough time for the Capsule Disc to fully rotate under the Auger.

### Tools and Materials Needed

- Disposable latex/rubber gloves (for food grade products and to protect hands from grease)
- Hairnet and/or beard net (food grade products only)
- Sterile shoe covers (food grade products only)

### Instructions

Note: Wear latex/rubber gloves (and appropriate food grade attire if applicable) during this process.

1. Run the Auger to determine the adjustment.
2. Press the button with the arrow facing in the right direction until the COUNTING OF FILLING display is blinking.



3. Press the up/down arrow areas on the buttons to adjust the amount of seconds the Auger will operate.

3.1 Note: Press the CLR areas on the buttons to clear the amount entirely.

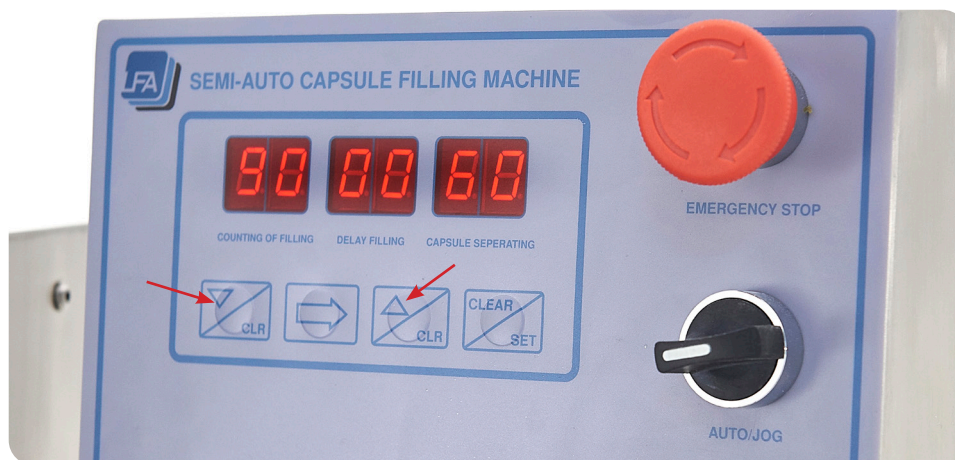

4. Press the SET area button after the adjustment is made.

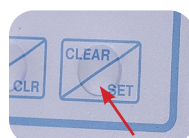

## Capsule Sewing Amount

The amount of capsules to be fed into the Capsule Discs needs to be adjusted any time the Tooling is changed.

### Tools and Materials Needed

- Disposable latex/rubber gloves (for food grade products and to protect hands from grease)
- Hairnet and/or beard net (food grade products only)
- Sterile shoe covers (food grade products only)

### Instructions

Note: Wear latex/rubber gloves (and appropriate food grade attire if applicable) during this process.

1. Press the button with the arrow facing in the right direction until the CAPSULE SEPARATING display is blinking.



2. Press the up/down arrow areas on the buttons to adjust the amount of capsules that will be separated.

2.1 Note: Press the CLR areas on the buttons to clear the amount entirely.

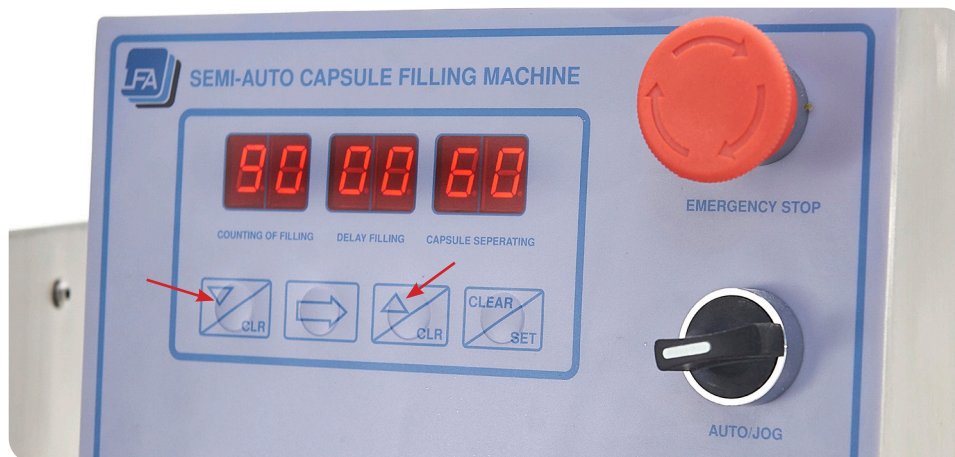

3. Press the SET area button after the adjustment is made.

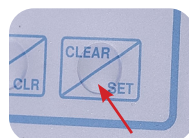

## Capsule Sewer Alignment

The SACF 25<sup>®</sup> comes with Alignment Tools that are used to ensure that the teeth sections of the Capsule Sewer are correctly positioned so that capsules can be smoothly inserted into the Capsule Discs.

### Tools and Materials Needed

- Set of metric Allen keys
- Alignment Tools from SACF 25<sup>®</sup> Toolkit
- Disposable latex/rubber gloves (for food grade products and to protect hands from grease)
- Hairnet and/or beard net (food grade products only)
- Sterile shoe covers (food grade products only)

### Instructions

Note: Wear latex/rubber gloves (and appropriate food grade attire if applicable) during this process.

1. Run the machine to determine the adjustment.



**WARNING:** To prevent any potential personal injury, ALWAYS push the SACF 25<sup>®</sup>'s Emergency Stop button when adjusting the Capsule Sewer alignment.

2. Remove the Perspex Covers from the top of the Capsule Hopper and the Capsule Sewing Repository.

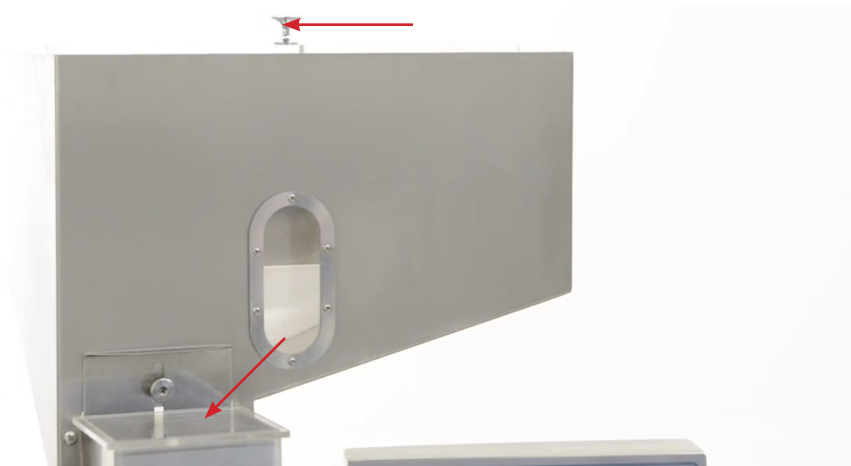

3. Ensure that the Capsule Hopper Gate is fully closed.



4. Remove the two bolts on the Capsule Hopper with an Allen key.

4.1 Note: Ensure to support the weight of the Capsule Hopper when removing the bolts.



5. Remove the Capsule Hopper from the machine.

5.1 Note: Be careful when removing the Capsule Hopper. The Capsule Magazine is fragile, so ensure not to knock it with the Capsule Hopper.



6. Loosen the Capsule Disc Mount with an Allen key.

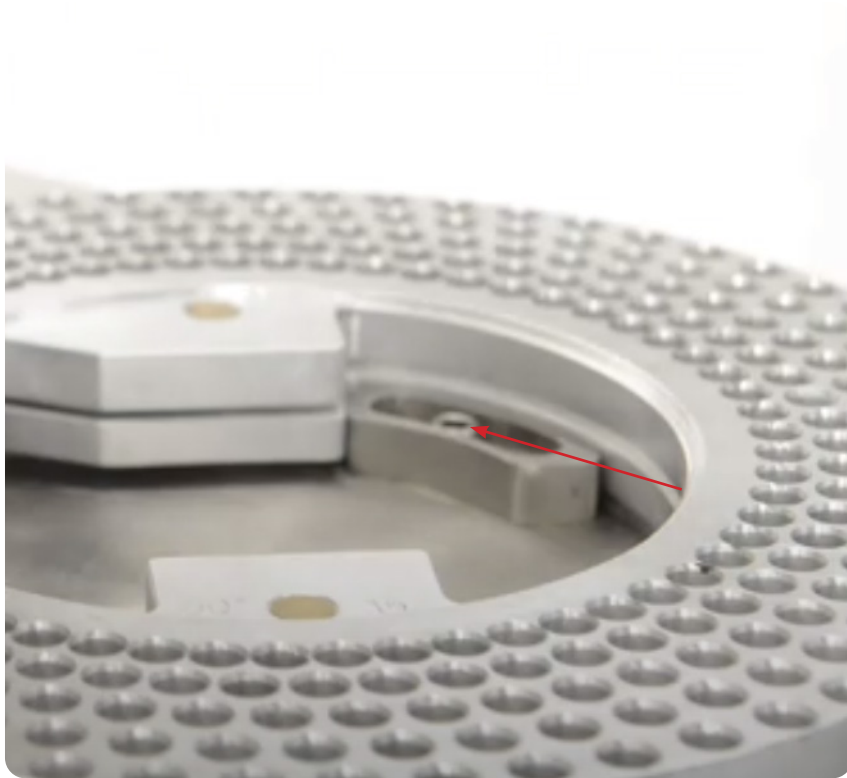

7. Insert the Alignment Tools inside the Capsule Discs and front teeth section.

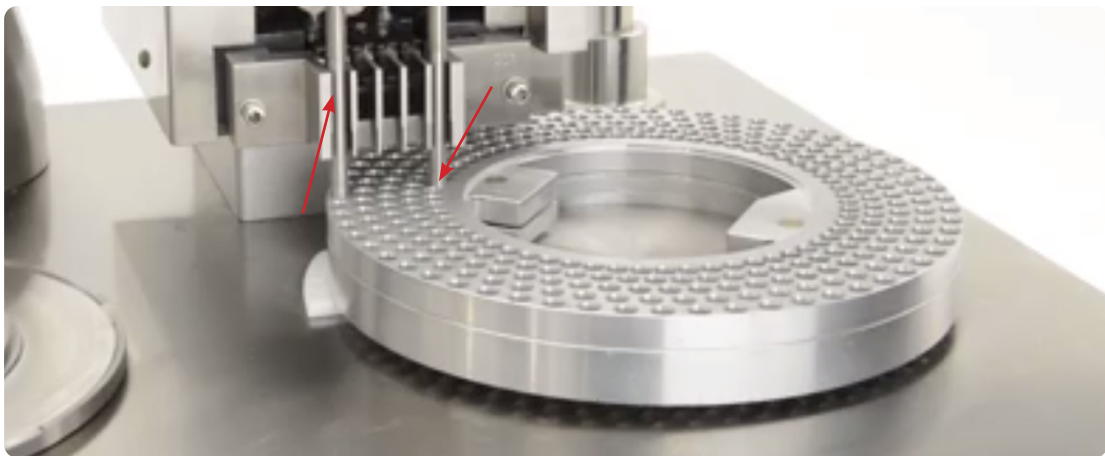

8. Adjust the Capsule Disc Mount and Capsule Discs so that the Alignment Tools rotate freely inside the front teeth section's ends.
9. Tighten the Capsule Disc Mount with an Allen key.
10. Insert two empty capsules into the slots inside the front teeth section's ends.
  - 10.1 Note: Ensure that the capsule bodies are in line with the front teeth.

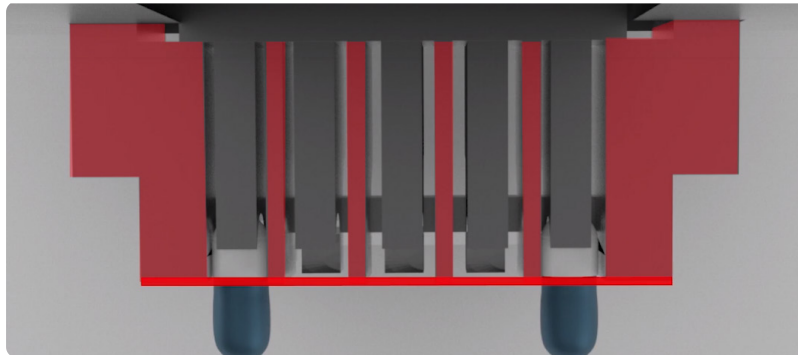
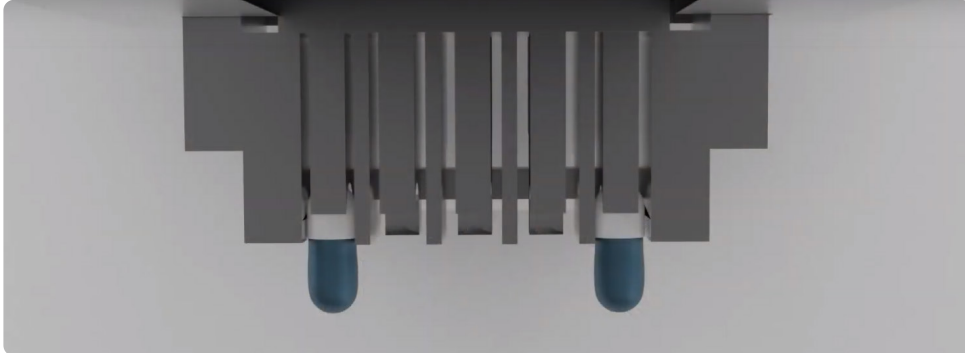



11. Plug in the machine.
12. Press the down arrow on the Capsule Sewer's VFD to lower the speed.
  - 12.1 Note: Lowering it to 10 is the appropriate speed.



13. Press the Capsule Sewing button and run the machine for one rotation to ensure the front and back teeth sections are in alignment.
  - 13.1 Note: If there is any noise from metal-on-metal scraping, immediately stop operating the machine and adjust the teeth alignments.



**WARNING:** To prevent any potential personal injury, keep hands and fingers away from the Capsule Sewer during operation.



## Air Pressure Recalibration

There are adjusters inside of the SACF 25<sup>®</sup> that control the air pressure of the Capsule Ejection Disc and the rotating arm of the filling mechanism. If there are operation issues with the Capsule Ejection Disc and filling mechanism, the air pressure must be recalibrated.

### Tools and Materials Needed

- Disposable latex/rubber gloves (for food grade products and to protect hands from grease)
- Hairnet and/or beard net (food grade products only)
- Sterile shoe covers (food grade products only)



**WARNING:** To prevent any potential personal injury, ALWAYS unplug the SACF 25<sup>®</sup> from the electrical outlet when adjusting the Air Pressure.

### Instructions

Note: Wear latex/rubber gloves (and appropriate food grade attire if applicable) during this process.

1. Remove the two door panels located in the back of the machine.
2. Raise the blue cap and turn to adjust the air pressure.

2.1 Note: The valve on the right-hand side controls the Capsule Ejection Disc's pressure. The valve to the left controls the pressure of the filling mechanism.



# Maintenance

To ensure that the SACF 25<sup>®</sup> will have a long operational life, maintenance is essential. This section includes methods for replacing parts, troubleshooting solutions, and how often to grease and clean your machines to keep its performance optimal.

## General Maintenance Prescriptions

- Use the maintenance checklist (found in the Appendix) before, during, and after machine operation.
- Make sure all grease points are maintained and regularly lubricated.
- Use an appropriate amount of lubricant. Excess grease can drip into the capsules.
- Before reassembling the machine after cleaning, make sure that the parts are dried and oiled.
- Constantly check for any loose nuts and/or screws before, during, and after machine operation.
- If the machine is not used for more than a week, place the Tooling in a container and cover in lubricant.

## Lubrication

Regularly greasing your machine is vital to prolonging its operational life. Parts that are not greased properly can make the machine seize up and cause major problems later. LFA recommends maintaining a lubrication schedule for your SACF 25<sup>®</sup>, which can be found in this section.

### Tools and Materials Needed

- NLGI Grade 1
- 460 Grade Worm Gear Oil
- Set of metric Allen keys with ball ends
- Adjustable wrench
- Crosshead screwdriver
- Permanent marker
- ISO 100 Grade Vacuum pump motor oil
- Vacuum pump motor oil filter
- Empty container
- Disposable latex/rubber gloves (for food grade products and to protect hands from grease)
- Hairnet and/or beard net (food grade products only)
- Sterile shoe covers (food grade products only)



**WARNING:** To prevent any potential personal injury, unplug the SACF 25<sup>®</sup> from the electrical outlet.

### Instructions

Note: Wear latex/rubber gloves (and appropriate food grade attire if applicable) during this process.

1. Remove the Capsule Hopper, the Powder Hopper, and the Capsule Magazine and teeth.

1.1 Note: Please refer to the remove and replace Tooling instructions on page 42 for further assistance.

2. Trace the washers on the mounting block with a permanent marker.
  - 2.1 Note: This is to mark the correct position of the bolts and washers in the mounting block for reinsertion.



3. Remove the mounting block from the machine by loosening its bolts with an Allen key.
4. Remove each of the four panels that enclose the Capsule Sewing Mechanism with an Allen key.



5. Apply grease to each of the bearings inside the Capsule Sewing Mechanism.



6. Remove the two door panels located in the back of the machine.

7. Apply oil to the Gearbox above the machine's electrics.

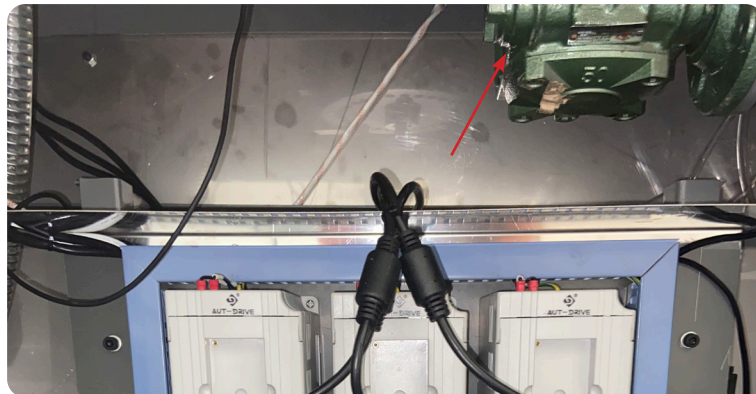



8. Place an empty container underneath the vacuum pump motor's oil outlet.
9. Remove the oil outlet's bolt with an adjustable wrench and drain the oil into the empty container.
10. Secure the oil outlet's bolt back on and remove the oil inlet's bolt.
11. Pour vacuum pump motor oil into the oil inlet until the window is topped off.
12. Remove the cover's bolts with a crosshead screwdriver.
13. Remove the blade with a crosshead screwdriver.
14. Unscrew the oil filter from the motor and replace it with the new one.
15. Reattach the blade with a crosshead screwdriver.
16. Reattach the cover with a crosshead screwdriver.
17. Reattach the oil inlet and oil outlet bolts with an adjustable screwdriver.

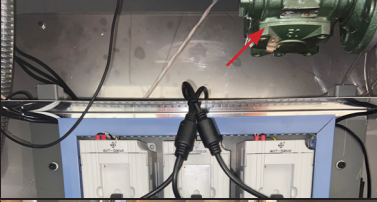

## Lubrication Schedule

LFA recommends the following SACF 25® parts to be lubricated according to the following frequency:

Part	Location	Image	Frequency	Type of Lubricant
Main Worm Gear	Mounted above the Motor in the lower section of the machine		Visually inspect through the eye glass and apply when dry (approximately weekly).	460 Grade Worm Gear Oil
Capsule Sewing Mechanism Bearings	Inside the Capsule Sewing Mechanism		Visually inspect and apply when dry (approximately monthly).	NLGI Grade 1
Tooling	Container		Cover and store in oil after cleaning.	Mineral Oil

## Dismantling for Repair and Replacement

Eventually due to wear and tear, some parts of the SACF 25<sup>®</sup> will need to be removed for repair and replacement. To prevent any delays in your capsule production, it is best practice to keep extra parts just in case.

To buy a SACF 25<sup>®</sup> part replacement, simply go to

<https://www.lfacapsulefillers.com/products/machine-spare-parts/sacf-range-spare-parts>

### Warranty

To access LFA's warranty policy, go to <https://www.lfacapsulefillers.com/warranty>

If your part is eligible for warranty, have your part's serial number on hand and please contact LFA:

#### UK

##### Phone

+44 01869 250234

##### Email

[support.uk@lfamachines.com](mailto:support.uk@lfamachines.com)

#### USA

##### Phone

+1 (682) 312-0034

##### Email

[support.usa@lfamachines.com](mailto:support.usa@lfamachines.com)

#### Taiwan

##### Phone

+886 422031790

##### Email

[support.asia@lfamachines.com](mailto:support.asia@lfamachines.com)



**WARNING:** To prevent any potential personal injury, ALWAYS unplug the SACF 25<sup>®</sup> from the electrical outlet when replacing parts.



## Wear Parts and Causes of Damage

Wear Part	Cause of Damage
Capsule Discs	The Capsule Discs on the SACF 25® hold the capsule bodies and caps while they are being filled. It would be a good idea to have spare a Capsule Disc to increase production capacities and in the event of a damaged occurring during cleaning or mishandling.
Teflon Wear Part on Vacuum Section	This wear part sits between the vacuum section and on the main body of the machine and the Capsule Discs when the capsules are being sewn. This part is prone to wear over time because it maintains a seal between the disc and the vacuum. If the seal becomes less tight, it could result in capsules not separating properly.
Teflon Wear Part on Bottom of Auger	This wear part sits between the Powder Hopper with its auger and the Capsule Disc that holds the capsule bodies that are being filled. This part is prone to wear over time because it maintains a seal between the plate and the auger, and a powder leak would result from this worn part.
Capsule Holding Pins	The Capsule Holding Pins hold the capsules in the cartridge and time their release. In the event of a jam, during cleaning, or mishandling, they can become damaged.

## Tooling

If you want to change size of a capsule, or if the Capsule Discs you currently have are damaged, it is necessary to change the Tooling.

To buy new Tooling from LFA, simply go to <https://www.lfacapsulefillers.com/sacf25-plates-moulds-set>

To watch a video of a SACF 25<sup>®</sup> Tooling change, go to <https://www.lfacapsulefillers.com/sacf-tooling-change>

### Tools and Materials Needed

- Set of metric Allen keys with ball ends
- 24 mm wrench
- Tooling (New Capsule Discs, Capsule Magazine, and Capsule Ejection Disc)
- Alignment Tools from SACF 25<sup>®</sup> Toolkit
- Empty capsules suited for new Tooling
- Disposable latex/rubber gloves (for food grade products and to protect hands from grease)
- Hairnet and/or beard net (food grade products only)
- Sterile shoe covers (food grade products only)



**WARNING:** To prevent any potential personal injury, ALWAYS unplug the SACF 25<sup>®</sup> from the electrical outlet when replacing parts.

### Instructions

Note: Wear latex/rubber gloves (and appropriate food grade attire if applicable) during this process.

#### Remove the Old Tooling

1. Remove the Perspex Covers from the top of the Capsule Hopper and the Capsule Sewing Repository.

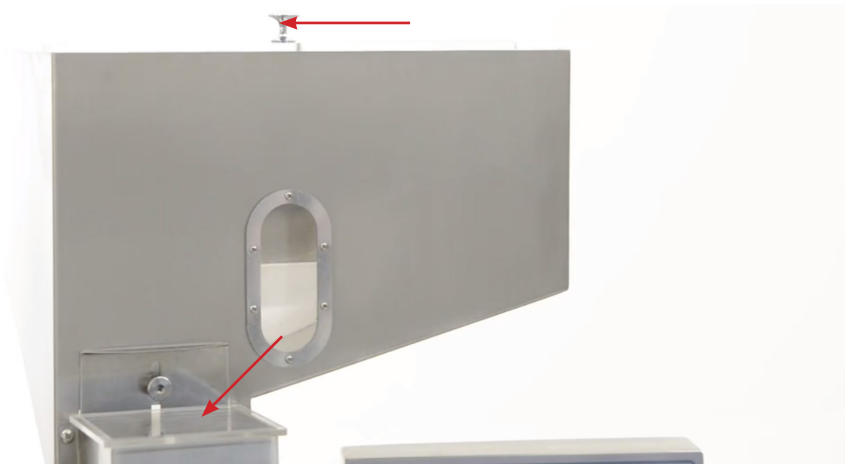

2. Ensure that the Capsule Hopper Gate is fully closed.



3. Remove the two bolts on the Capsule Hopper with an Allen key.

3.1 Note: Ensure to support the weight of the Capsule Hopper when removing the bolts.



4. Remove the Capsule Hopper from the machine.

4.1 Note: Be careful when removing the Capsule Hopper. The Capsule Magazine is fragile, so ensure not to knock it with the Capsule Hopper.



5. Remove the Capsule Discs from the machine.
6. Remove the front two bolts of the sewing section with an Allen key.- 6.1 Note: Ensure to keep hold of the Capsule Magazine to prevent it from falling.

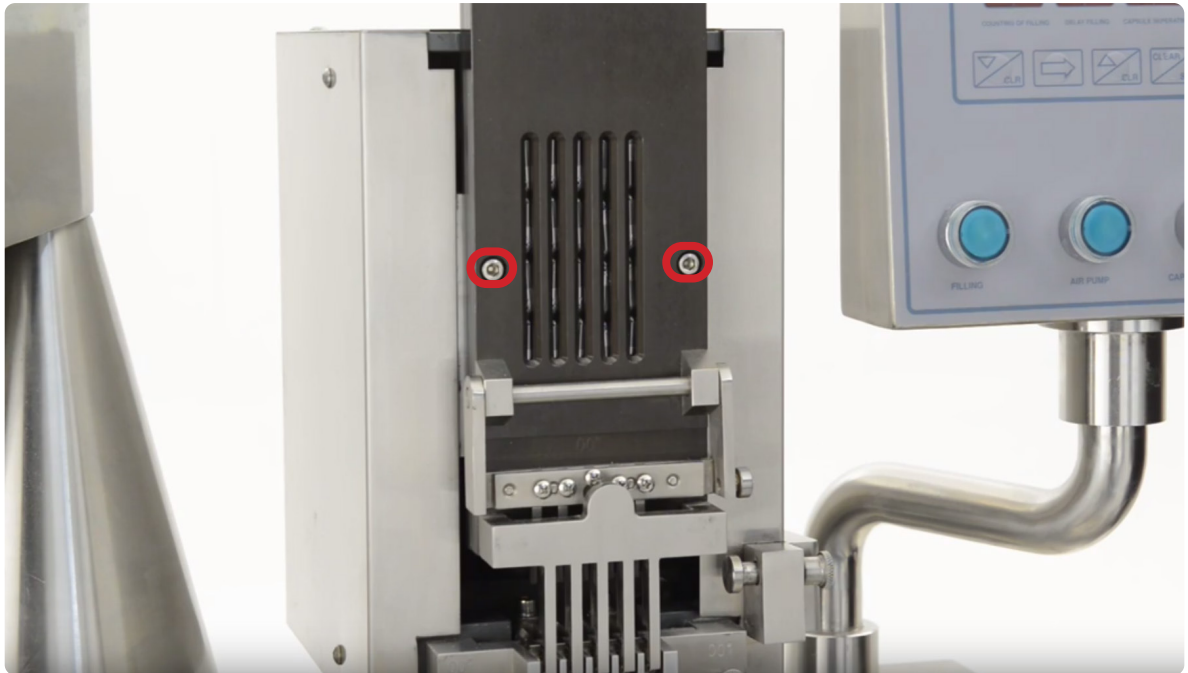

7. Remove the bolts from the front teeth section of the Capsule Sewer with an Allen key.



8. Pull out the front teeth section from the Capsule Sewer.



9. Remove the bolts in the back teeth section of the Capsule Sewer with an Allen key.



10. Pull out the back teeth section of the Capsule Sewer.

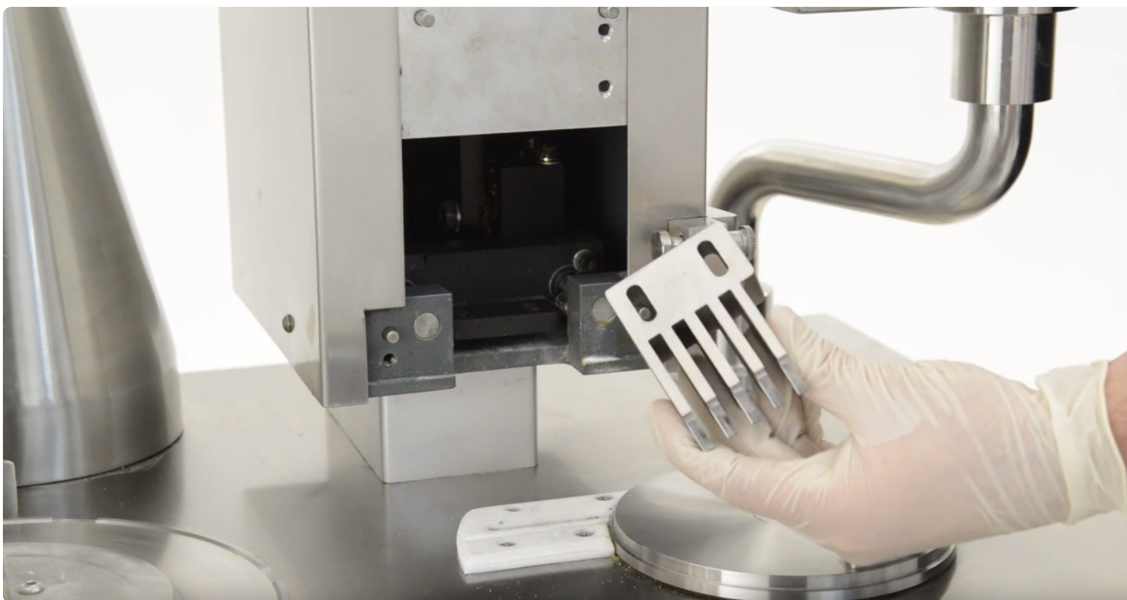

11. Remove the nut and washer from the Capsule Ejection Disc with a 24 mm wrench.

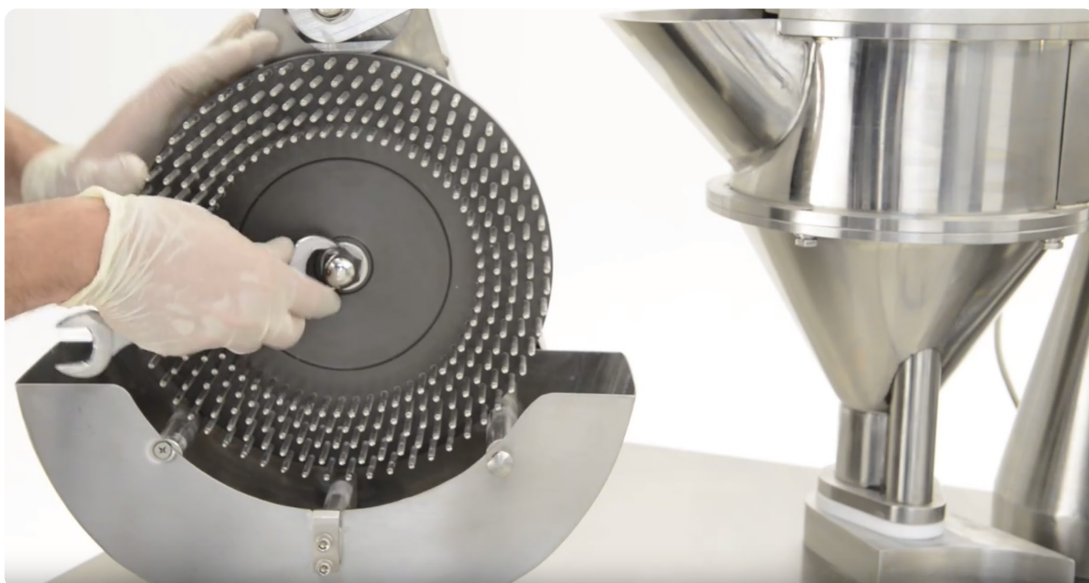

12. Pull out the Capsule Ejection Disc from the sealing section.



**Replace the Tooling**

13. Insert the new Capsule Ejection Disc into the sealing section.

13.1 Note: Ensure that the new Capsule Ejection Disc is secure on the thread.



14. Insert the washer and nut back on the thread and tighten with a 24 mm wrench.

15. Insert the new back teeth section and secure the two bolts fingertight.

15.1 Note: The new back teeth section should be loose and able to move.



16. Insert the new front teeth section and secure the two bolts fingertight.

16.1 Note: The new front teeth section should be loose and able to move.



17. Insert the new Capsule Discs in front of the sewing section.

18. Insert the Alignment Tools inside the new Capsule Discs and front teeth section.



19. Loosen the Capsule Disc Mount with an Allen key.

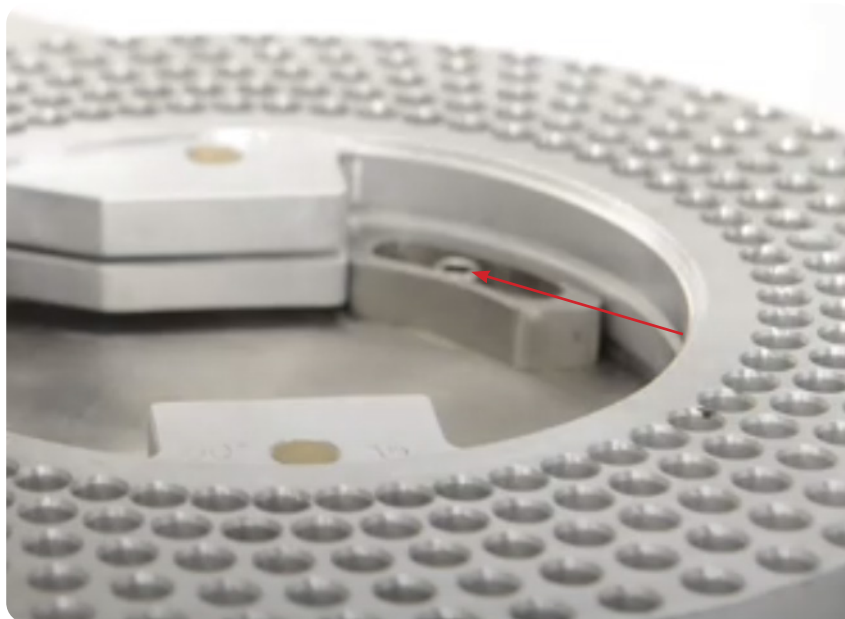

20. Adjust the Capsule Disc Mount and the new Capsule Discs.

20.1 Note: Ensure that the Alignment Tools rotate freely inside the front teeth section's ends and the Capsule Discs.

21. Rotate the Capsule Discs clockwise to secure them on the turntable.

22. Tighten the Capsule Disc Mount with an Allen key.

23. Tighten the front teeth section's bolts with an Allen key.



24. Insert two empty capsules into the slots inside the front teeth section's ends.  
24.1 Note: Ensure that the capsule bodies are in line with the front teeth.

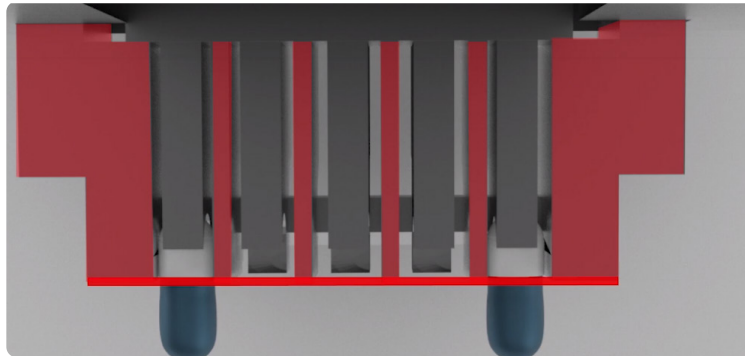

25. Plug in the machine.  
26. Press the down arrow on the Capsule Sewer's VFD to lower the speed.  
26.1 Note: Lowering it to 10 is the appropriate speed.



27. Press the Capsule Sewing button and run the machine for one rotation to ensure the front and back teeth sections are in alignment.  
27.1 Note: If there is any noise from metal-on-metal scraping, immediately stop operating the machine and adjust the teeth alignments.



**WARNING:** To prevent any potential personal injury, keep hands and fingers away from the Capsule Sewer during operation.



28. Tighten the back teeth section's bolts with an Allen key.
29. Run the machine for one more rotation to ensure that the Capsule Sewer is operating correctly.
30. Run the Capsule Sewer until it is at its highest position.
31. Insert the new Capsule Magazine onto the Capsule Sewing Mechanism's pins.



32. Tighten the new Capsule Magazine's two bolts fingertight.
33. Ensure that all the teeth in the new Capsule Magazine and the rest of Capsule Sewing Mechanism are aligned and fully tighten the two bolts with an Allen key.
34. Insert empty capsules into each slot of the top of the new Capsule Magazine.



35. Press the Capsule Sewing button and run the machine for one rotation to ensure that the capsules are inserted into the Capsule Discs correctly.

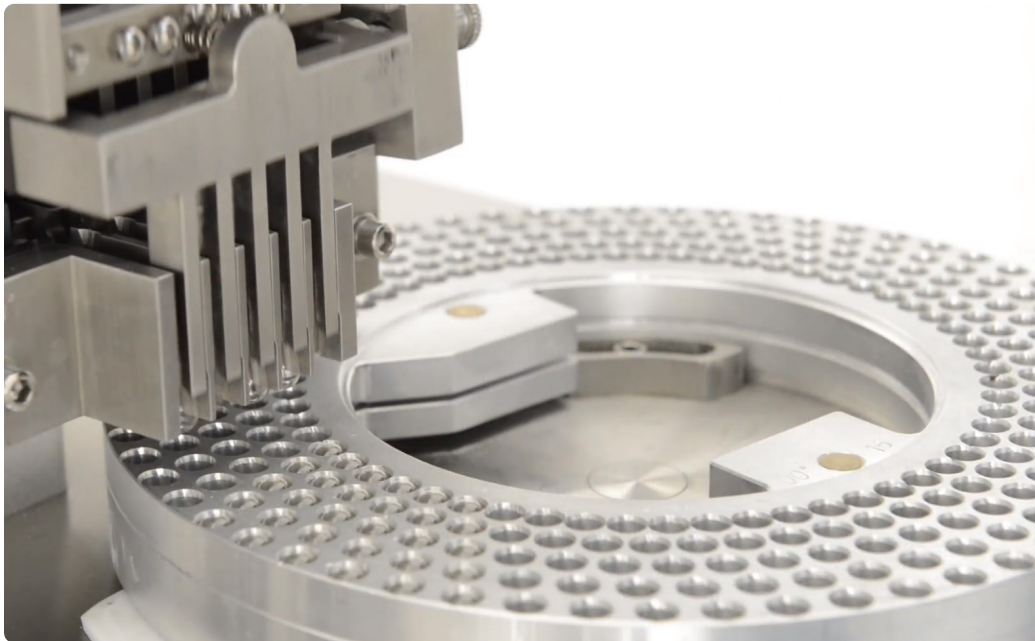

36. Reinsert the Capsule Hopper on top of the new Capsule Magazine.  
36.1 Note: Ensure not to knock the new Capsule Magazine.



37. Reattach the Capsule Hopper to the machine by tightening its two bolts with an Allen key.  
38. Reinsert the Perspex Covers from the top of the Capsule Hopper and the Capsule Sewing Repository.

39. Operate the machine for a few runs to ensure that it is running correctly.

39.1 Note: If there is any noise from metal-on-metal scraping, immediately stop operating the machine and adjust the teeth alignments.

## Vacuum Section Teflon Wear Part

This wear part sits between the vacuum section on the main body of the machine and the Capsule Discs when the capsules are being sewn. It maintains a seal between the disc and the vacuum.

### Tools and Materials Needed

- Crosshead screwdriver
- New vacuum section teflon wear part
- Disposable latex/rubber gloves (for food grade products and to protect hands from grease)
- Hairnet and/or beard net (food grade products only)
- Sterile shoe covers (food grade products only)



**WARNING:** To prevent any potential personal injury, ALWAYS unplug the SACF 25® from the electrical outlet when replacing parts.

### Instructions

Note: Wear latex/rubber gloves (and appropriate food grade attire if applicable) during this process.

#### Remove the Vacuum Section Teflon Part

1. Remove the Capsule Discs from the machine.
2. Remove each screw from the teflon wear part with a cross head screwdriver.



#### Replace the Vacuum Section Teflon Part

3. Position the new teflon wear part underneath the Capsule Sewer.
4. Secure the the new teflon wear part's screws with a crosshead screwdriver.
5. Reposition the Capsule Discs in front of the Capsule Sewer.

## Auger Teflon Wear Part

This wear part sits between the Auger and the Capsule Disc that holds the capsule bodies that are being filled. It maintains a seal between the plate and the Auger.

### Tools and Materials Needed

- 13 mm wrench
- Crosshead screwdriver
- New Auger teflon wear part
- Disposable latex/rubber gloves (for food grade products and to protect hands from grease)
- Hairnet and/or beard net (food grade products only)
- Sterile shoe covers (food grade products only)



**WARNING:** To prevent any potential personal injury, ALWAYS unplug the SACF 25<sup>®</sup> from the electrical outlet when replacing parts.

### Instructions

Note: Wear latex/rubber gloves (and appropriate food grade attire if applicable) during this process.

#### Remove the Auger Teflon Wear Part

1. Loosen the Powder Hopper's bolts with a 13 mm wrench.



2. Reach inside the Powder Hopper's mouth and grab onto the Auger.



3. Pull up the top of the Powder Hopper and the Auger from the machine.



4. Remove the lower bolts on the Powder Hopper with a 13 mm wrench.

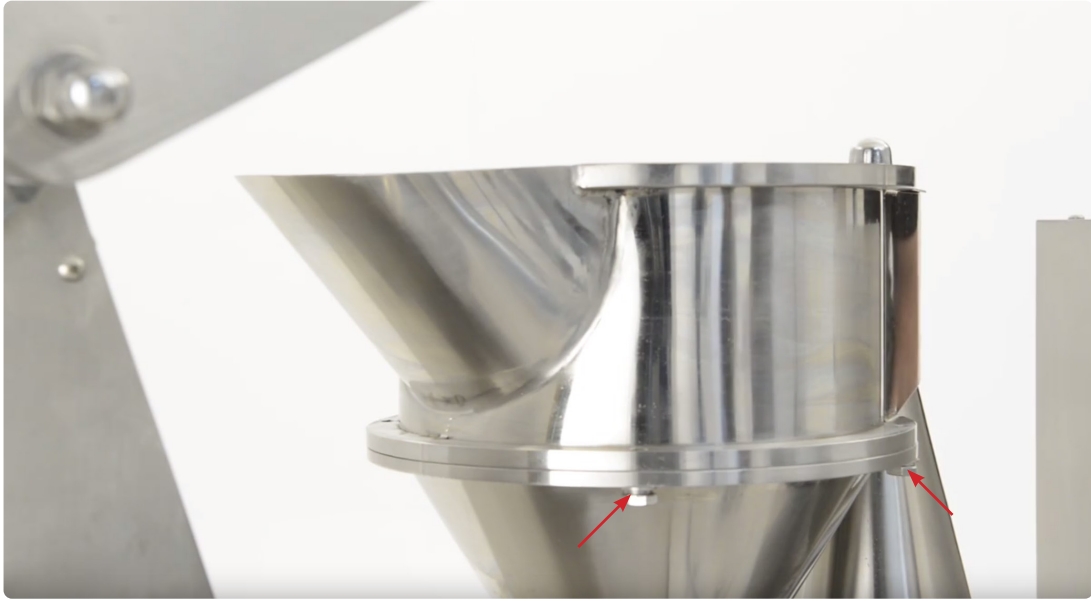

5. Remove the bottom of the Powder Hopper.

6. Remove the Auger teflon wear part with a crosshead screwdriver.



**Replace the Auger Teflon Wear Part**

7. Secure the new Auger teflon wear part with a crosshead screwdriver.

8. Resecure the bottom bolts of the Powder Hopper with a 13 mm wrench.



9. Resecure the top bolts of the Powder Hopper with a 13 mm wrench.

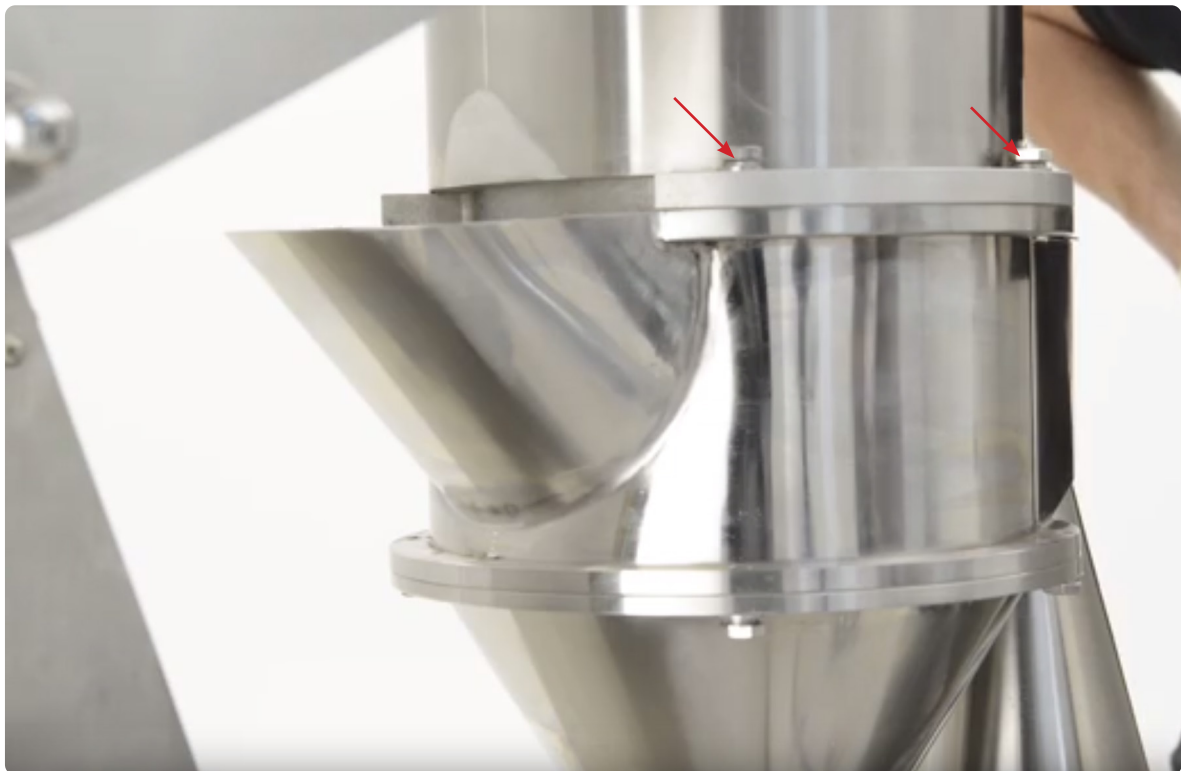



## Capsule Holding Pins

The Capsule Holding Pins hold the capsules in the cartridge and time their release. In the event of a jam, during cleaning, or mishandling, they can become damaged.

### Tools and Materials Needed

- Set of metric Allen keys with ball ends
- Crosshead screwdriver
- New Capsule Holding Pins
- Disposable latex/rubber gloves (for food grade products and to protect hands from grease)
- Hairnet and/or beard net (food grade products only)
- Sterile shoe covers (food grade products only)



**WARNING:** To prevent any potential personal injury, ALWAYS unplug the SACF 25<sup>®</sup> from the electrical outlet when replacing parts.

### Instructions

Note: Wear latex/rubber gloves (and appropriate food grade attire if applicable) during this process.

#### Remove the Capsule Holding Pins

1. Remove the Perspex Covers from the top of the Capsule Hopper and the Capsule Sewing Repository.

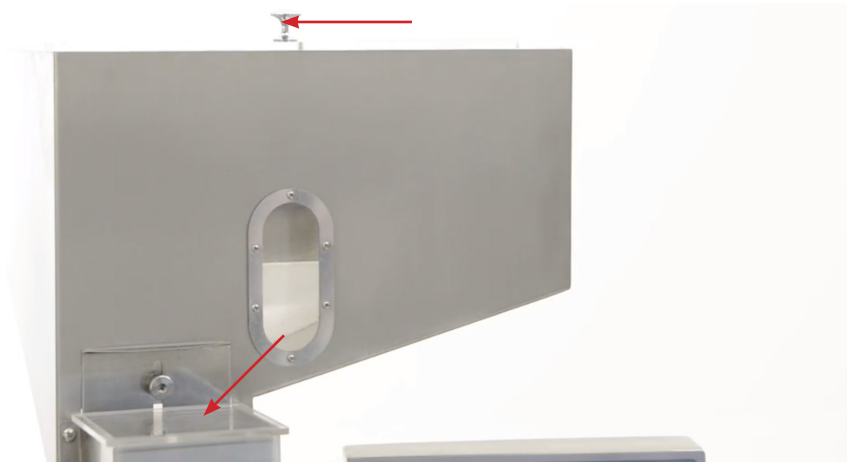

2. Ensure that the Capsule Hopper Gate is fully closed.



3. Remove the two bolts on the Capsule Hopper with an Allen key.

3.1 Note: Ensure to support the weight of the Capsule Hopper when removing the bolts.

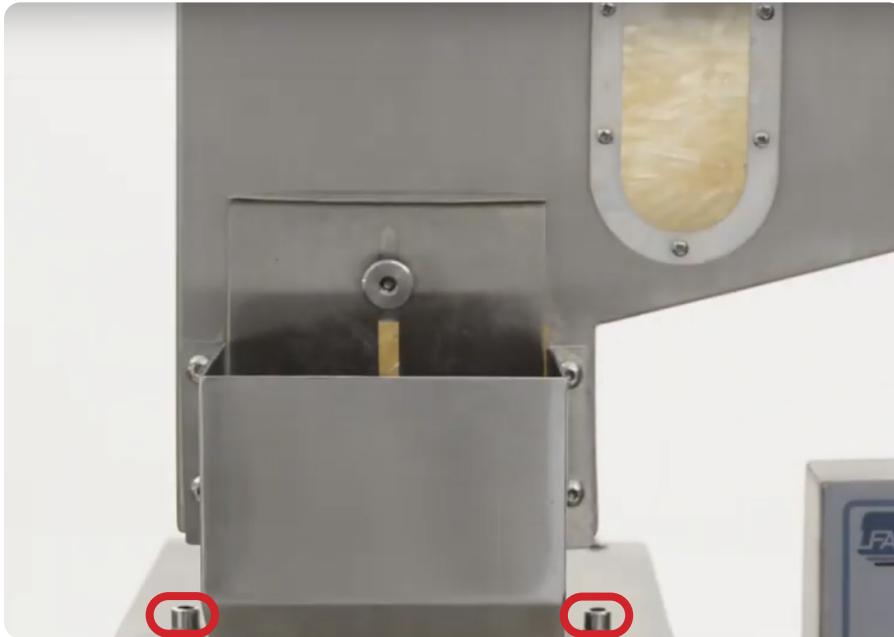

4. Remove the Capsule Hopper from the machine.

4.1 Note: Be careful when removing the Capsule Hopper. The Capsule Magazine is fragile, so ensure not to knock it with the Capsule Hopper.



5. Remove the front two bolts of the sewing section with an Allen key.

5.1 Note: Ensure to keep hold of the Capsule Magazine to prevent it from falling.

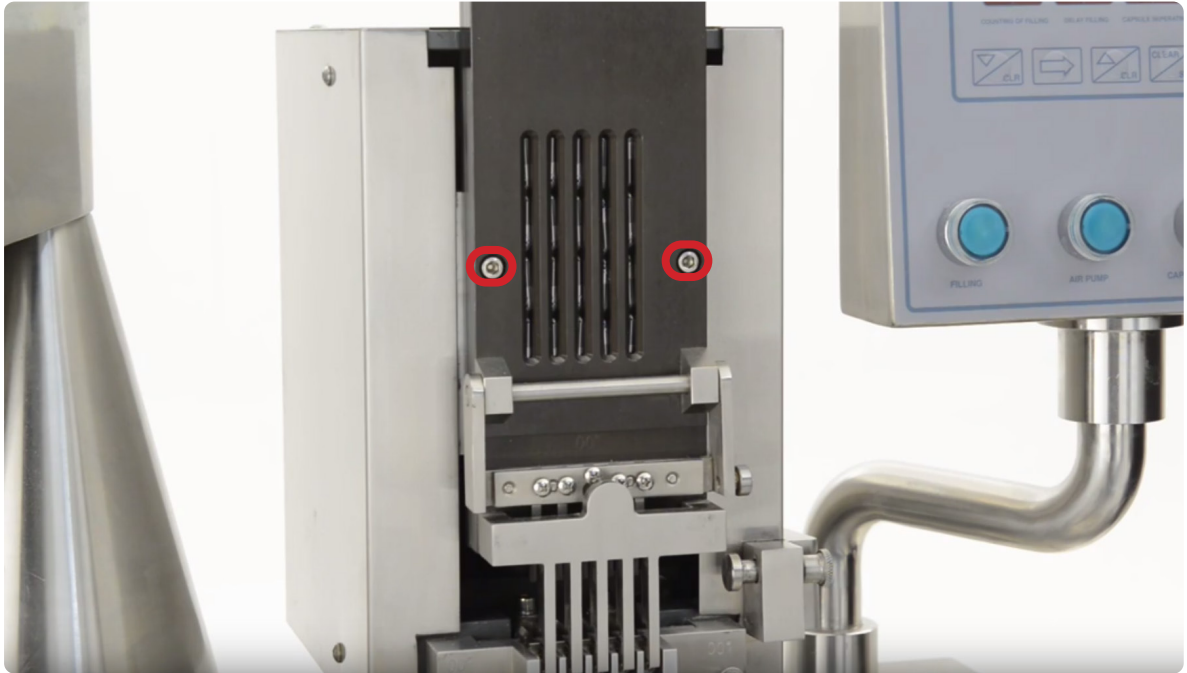

6. Remove the screws on the back of the Capsule Magazine with a crosshead screwdriver.



7. Remove the bolts that hold the Capsule Magazine's teeth with an Allen key.

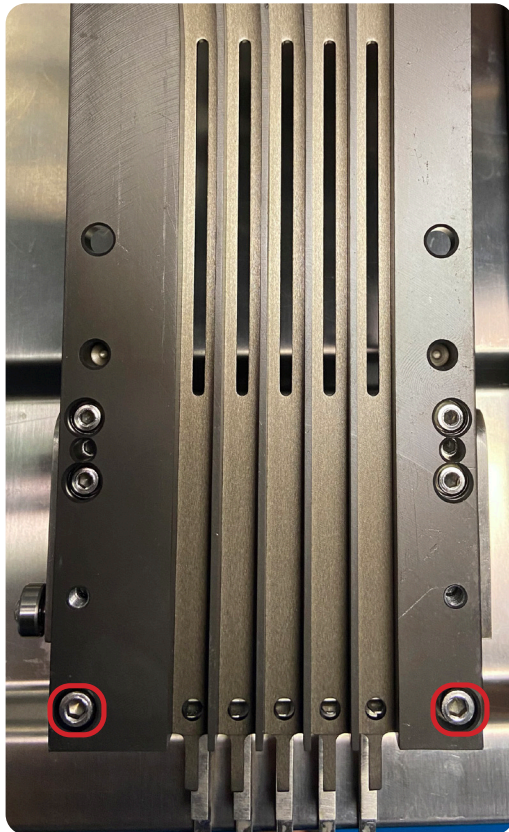

8. Set aside the Capsule Magazine's teeth.

8.1 Note: Be careful not to lose the spring.

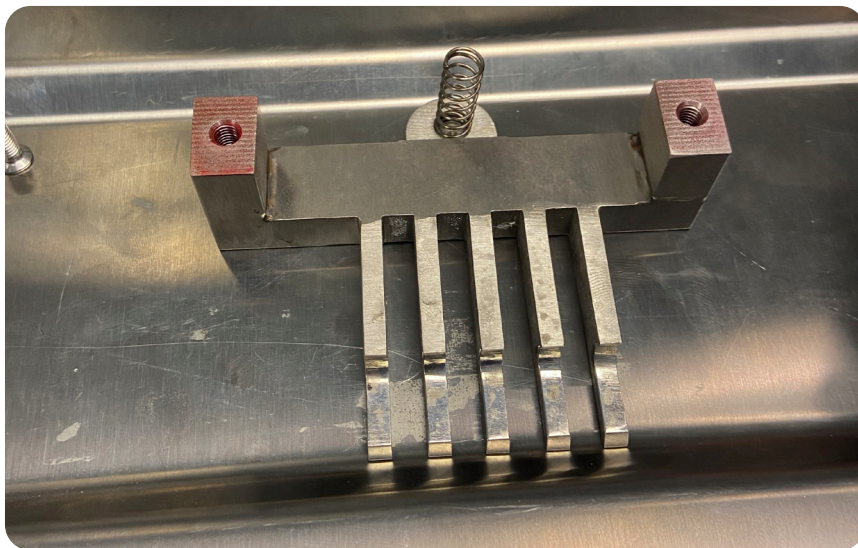

9. Remove the Capsule Holding Pins' screws with a crosshead screwdriver.
10. Remove the Capsule Holding Pins from the Capsule Magazine.

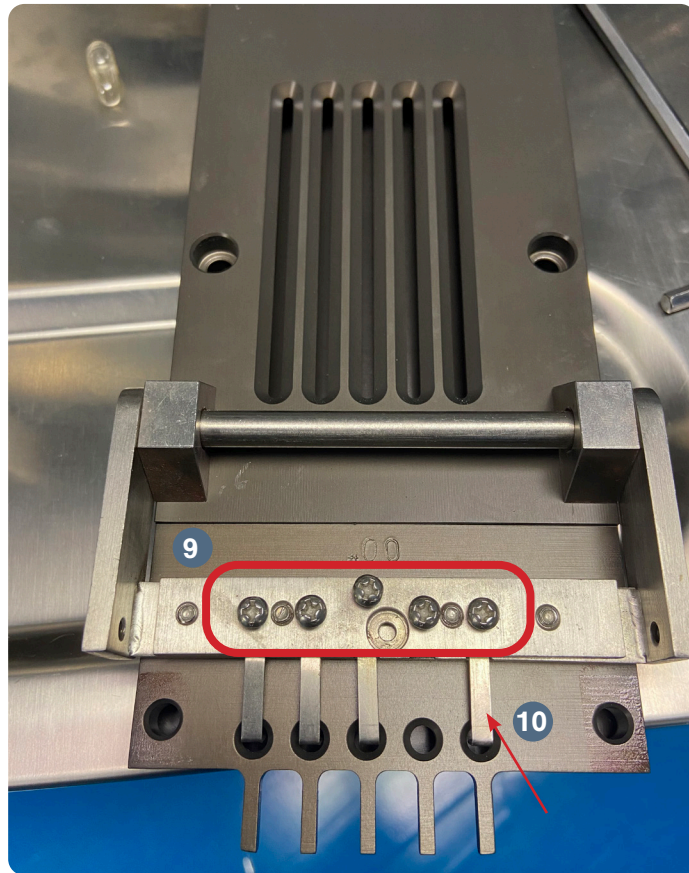

#### Replace the Capsule Holding Pins

11. Insert one of the new Capsule Holding Pins into the Capsule Magazine.
  - 11.1 Note: Ensure that the new Capsule Holding Pin is straight and inserted at the correct length.
12. Tighten the new Capsule Holding Pin's screw with a crosshead screw driver.
13. Repeat steps 11-12 until all new Capsule Holding Pins are installed.
14. Reinsert the Capsule Magazine's teeth and secure them with an Allen key.
  - 14.1 Note: Ensure that the spring correctly inserted as well.
15. Ensure that the new Capsule Holding Pins are all aligned and in the correct position.
  - 15.1 Note: If the alignment is off, take off the Capsule Magazine's teeth and adjust accordingly.

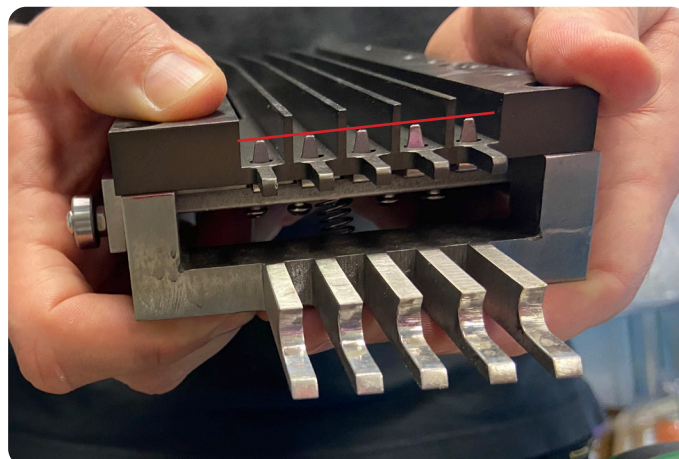

16. Plug in the machine.

17. Press the down arrow on the Capsule Sewer's VFD to lower the speed.

17.1 Note: Lowering it to 10 is the appropriate speed.



**WARNING:** To prevent any potential personal injury, keep hands and fingers away from the Capsule Sewer during operation.



18. Run the Capsule Sewer until it is at its highest position.

19. Insert the Capsule Magazine onto the Capsule Sewing Mechanism's pins.



20. Tighten the Capsule Magazine's two bolts fingertight.

21. Ensure that all the teeth in the Capsule Magazine and the rest of Capsule Sewing Mechanism are aligned and fully tighten the two bolts with an Allen key.

22. Insert empty capsules into each slot of the top of the Capsule Magazine.



23. Press the Capsule Sewing button and run the machine for one rotation to ensure that the capsules are inserted into the Capsule Discs correctly.

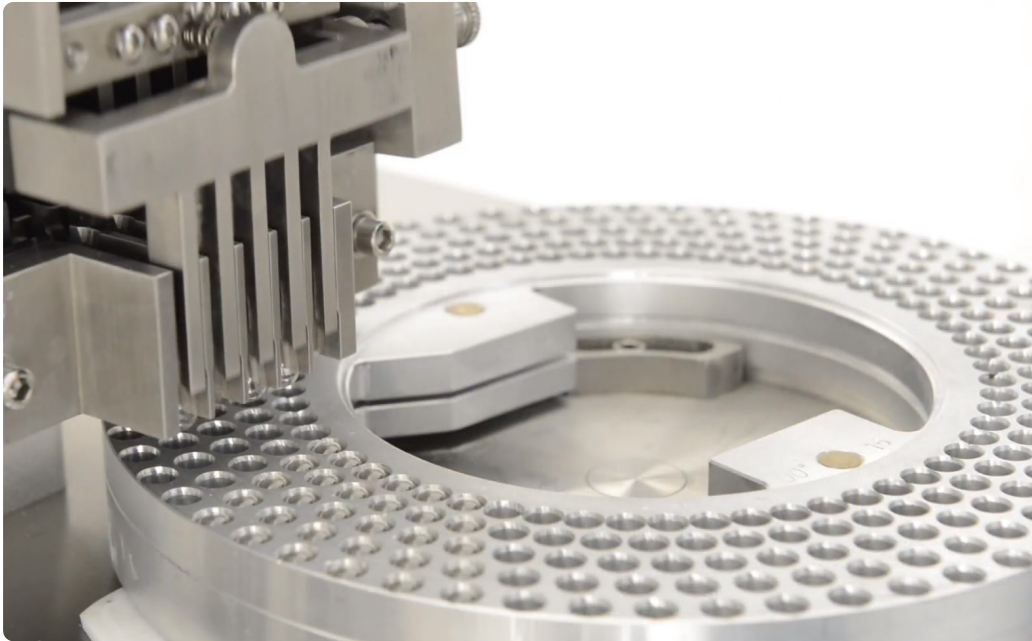

24. Reinsert the Capsule Hopper on top of the Capsule Magazine.  
24.1 Note: Ensure not to knock the Capsule Magazine.



25. Reattach the Capsule Hopper to the machine by tightening its two bolts with an Allen key.  
26. Reinsert the Perspex Covers from the top of the Capsule Hopper and the Capsule Sewing Repository.

27. Operate the machine for a few runs to ensure that it is running correctly.

27.1 Note: If there is any noise from metal-on-metal scraping, immediately stop operating the machine and adjust the teeth alignments.



## Vacuum Pump Filter Bag

The Filter Bag in the machine's Vacuum Pump collects dust and debris and may need to be eventually replaced.

### Tools and Materials Needed

- New Vacuum Pump Filter Bag
- Disposable latex/rubber gloves (for food grade products and to protect hands from grease)
- Hairnet and/or beard net (food grade products only)
- Sterile shoe covers (food grade products only)



**WARNING:** To prevent any potential personal injury, ALWAYS unplug the SACF 25® from the electrical outlet when replacing parts.

### Instructions

Note: Wear latex/rubber gloves (and appropriate food grade attire if applicable) during this process.

#### Remove the Vacuum Pump Filter Bag

1. Unscrew the thumb nuts and washers that secure the Vacuum Pump's cover by hand.



2. Carefully remove the Vacuum Pump's cover and set aside.
3. Lift up the Filter Bag off of the Vacuum Pump.

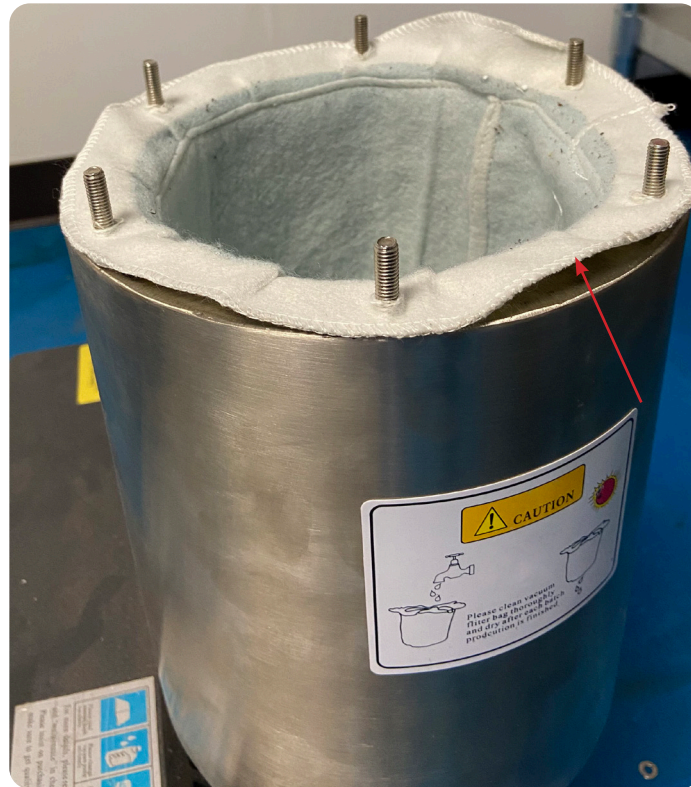

#### **Replace the Vacuum Pump Filter Bag**

4. Insert the new Filter Bag over the bolts and into the Vacuum Pump.
5. Place the cover back over the Vacuum Pump.
6. Tighten the washers and thumb nuts back on the bolts.

# Troubleshooting

Sometimes unavoidable issues will occur while operating the SACF 25<sup>®</sup>. Fortunately, there are several methods to remedy these issues.

## Common Issues

Symptom	Possible Cause	Possible Solution
<b>Capsule caps fly from machine</b>	The vacuum pressure is too high.	Adjust the vacuum pressure to approximately 0.03-0.04 MPa.
<b>Two capsules are inserted into the Capsule Discs at the same time</b>	The Capsule Sewing Mechanism's gate opens too early.	Adjust the mounting block so that the Sewing Section's gate allows the capsules to be center in the Capsule Discs' holes.
<b>Capsules are not inserted into the Capsule Discs</b>	The Capsule Discs' holes and the Capsule Sewing Mechanism teeth are not aligned/out of sync.	Use the Alignment Tools that come in the SACF 25 <sup>®</sup> Toolkit to realign the Capsule Discs and Capsule Sewing Mechanism teeth.
<b>Capsule caps and bodies do not separate</b>	The vacuum pump's pressure needs to be adjusted.	Increase the vacuum pump pressure.
	The capsule sizes are inappropriate for the Tooling and/or capsules are defective.	Ensure that the capsules are standard-compliant and an appropriate size for the Tooling.
<b>The capsules' fill measurements are inconsistent/uneven</b>	The Capsule Disc is not in the correct position.	Reinsert the Capsule Disc and ensure that it is securely on its insert.
	There is not enough powder in the Powder Hopper.	Pour more powder into the Powder Hopper.
	The Tooling is damaged.	Remove and replace the Tooling (Capsule Discs, Capsule Magazine, and Capsule Ejection Disc)
<b>The fill dosage is too high or too low</b>	The speed of the Capsule Disc rotation and Auger inside of Powder Hopper is inconsistent.	Adjust the Capsule Disc's rotation speed and the Auger to until they are consistent.
	The air pressure is not high enough to make the Capsule Disc rotate.	Check and adjust the air pressure to be around 0.4-0.7 MPa.
<b>Capsules are locking too tight or too loose</b>	The air pressure is too high or not high enough.	Adjust the air pressure to be around 0.4-0.7 MPa.
	The water content of the powder is too high.	Reduce the working environment's humidity to below 45% and/or dry the powder.

## Common Issues Continued

Symptom	Possible Cause	Possible Solution
<b>Capsules are not being fed through the Capsule Magazine's tracks</b>	The Capsule Magazine is clogged.	Remove the Capsule Magazine and run the cleaning brush included with the SACF 25® Toolkit through the tracks.
	The Capsule Magazine is out of alignment.	Adjust the Capsule Magazine so that the capsules can be fed into the Capsule Discs.
<b>Capsules do not seal</b>	The Capsule Discs are caked with powder/capsules are stuck.	Clean the Capsule Discs' holes.
<b>Split capsules</b>	There is too much powder being distributed.	Increase turntable speed.
		Use less powder.
		Use larger capsules.
	Caps and bodies are sealed too tight.	Decrease the Capsule Sealer pressure.
	The capsules have been exposed to moisture.	Improve capsule storage conditions.
<b>Varying fill weights</b>	There is too much powder being distributed.	Increase turntable speed.
		Use less powder.
		Use larger capsules.
<b>There are metal shavings in the capsule powder filling station area</b>	The gap between the Capsule Disc and capsule filling area is too narrow.	Loosen the three bolts underneath the Capsule Disc and adjust.

## Common Issues Continued

Symptom	Possible Cause	Possible Solution
<b>Dented in capsules</b>	The capsules are being overfilled.	Use larger capsules.
		Use less powder.
	The capsules have been exposed to moisture.	Improve capsule storage conditions.
<b>Telescoped capsules</b>	Machine components are not installed correctly or worn out.	Adjust or replace the worn out components.
	The capsule fill weight is too high.	Lower the capsule fill weight.
	The capsules' storage area experiences variation in temperature.	Store the capsules in an area with a consistent temperature.
<b>Improperly closed capsules</b>	There is damage to the body-cap interface (sealing area).	Replace the damaged capsules.
	The capsules are being overfilled.	Use larger capsules.
		Use less powder.
<b>Dusty capsules</b>	Capsules are not being polished.	Use a capsule polisher after filling capsules. Order one from LFA at <a href="https://www.lfacapsulefillers.com/cp-7000-capsule-polisher">https://www.lfacapsulefillers.com/cp-7000-capsule-polisher</a>
<b>Powder is stuck to capsules</b>	The powder content is sticky.	Granulate or add lubrication to your mix.
	The working environment is too humid/has too much static.	Reduce the humidity and ground your machine/remove static.

# De-Jamming the SACF 25<sup>®</sup>

There are several reasons why a SACF 25<sup>®</sup> might jam such as:

- Disfigured capsules become lodged in magazine tracks.
- Powder builds up in the machine.
- Capsule Holding Pins are out of alignment.

The methods that can fix a jammed SACF 25<sup>®</sup> follow below:

## Tools and Materials Needed

- Set of metric Allen keys with ball ends
- Crosshead screwdriver
- Cleaner (e.g. Member's Mark Commercial Lemon Fresh Disinfectant)
- Sanitizer (e.g. Member's Mark Commercial Sanitizer)
- Bowl of warm soapy water (nothing abrasive)
- 3 clean cloths
- Disposable latex/rubber gloves (for food grade products and to protect hands from grease)
- Hairnet and/or beard net (food grade products only)
- Sterile shoe covers (food grade products only)



**WARNING:** To prevent any potential personal injury, ALWAYS unplug the SACF 25<sup>®</sup> before de-jamming it.

## Instructions

Note: Wear latex/rubber gloves (and appropriate food grade attire if applicable) during this process.

### Method 1: Dislodge Disfigured Capsules

1. Remove the Capsule Hopper and the Capsule Magazine and its teeth.
  - 1.1 Note: Please refer to the remove and replace Capsule Holding Pins instructions on page 57 for further assistance.
2. Take apart the Capsule Magazine with an Allen key and remove any stuck/damaged capsules.
  - 2.1 Note: Please refer to the remove and replace Capsule Holding Pins instructions on page 57 for further assistance.

### **Method 2: Clean Excess Powder Buildup**

1. Remove the Capsule Hopper, the Powder Hopper, the Capsule Magazine and teeth, the Capsule Discs, the Capsule Ejection Disc, and the Auger.

1.1 Note: Please refer to the remove and replace Tooling instructions on page 42 for further assistance and the remove and replace Auger Teflon Wear Part instructions on page 53 for further assistance.

2. Take one of the parts removed from the machine and bring it to the bowl of soapy water.

2.1 Note: To ensure that all dirt and debris are removed, wash one part at a time.

3. Take a clean cloth and carefully wash the part thoroughly.

3.1 Note: Use the toothbrush for difficult-to-remove debris. When cleaning Tooling, use non-abrasive cleaning equipment such as a soft pipe cleaner and soft cloth.

4. Dry part immediately after it is cleaned and rinsed.

5. Sanitize part with a clean cloth.

6. Repeat steps 2-6 for each remaining part until they are all clean.

### **Method 3: Realign the Capsule Holding Pins**

1. Remove the Capsule Hopper and the Capsule Magazine and its teeth.

1.1 Note: Please refer to the remove and replace Capsule Holding Pins instructions on page 57 for further assistance.

2. Remove the Capsule Holding Pins' screws with a crosshead screwdriver.

3. Adjust the Capsule Holding Pins until they are all straight and correctly aligned.

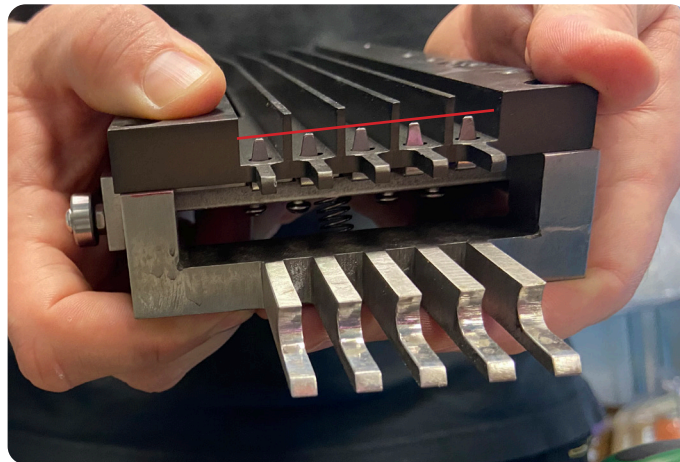

# Cleaning

During the SACF 25<sup>®</sup>'s operation, excess powder will find its way into parts of the machine, particularly in the Capsule Discs, Capsule Magazine, and the Excess Powder Collector on the machine's frame. It is important to clean the SACF 25<sup>®</sup> thoroughly to prevent rusting and cross contamination.

LFA recommends that the machine be cleaned after each operation.

## Tools and Materials Needed

- Cleaning brush/paintbrush
- Bagless vacuum
- Long wire pipe cleaner
- Toothbrush
- Cleaner (e.g. Member's Mark Commercial Lemon Fresh Disinfectant)
- Sanitizer (e.g. Member's Mark Commercial Sanitizer)
- Set of metric Allen keys with ball ends
- Crosshead screwdriver
- Disposable latex/rubber gloves
- Bowl of warm soapy water (nothing abrasive)
- 3 clean cloths
- Potable water
- Hairnet and/or beard net (food grade products only)
- Sterile shoe covers (food grade products only)



**WARNING:** To prevent any potential personal injury, ALWAYS unplug the SACF 25<sup>®</sup> from the electrical outlet when removing and replacing parts.

## Instructions

Note: Wear latex/rubber gloves (and appropriate food grade attire if applicable) during this process.

### Remove Parts

1. Remove the Capsule Hopper, the Powder Hopper, the Capsule Magazine and teeth, the Capsule Discs, the Capsule Ejection Disc, and the Auger.

1.1 Note: Please refer to the remove and replace Tooling instructions on page 42 and the remove and replace Auger Teflon Wear Part instructions on page 53 for further assistance.

2. Use a brush to bring powder debris out from hard to reach places.

3. Vacuum the top section of the SACF 25<sup>®</sup>.





### Clean the Parts

4. Take one of the parts removed from the machine and bring it to the bowl of soapy water.
  - 4.1 Note: To ensure that all dirt and debris are removed, wash one part at a time.
5. Take a clean cloth and carefully wash the part thoroughly.
  - 5.1 Note: Use the toothbrush for difficult-to-remove debris. When cleaning Tooling, use non-abrasive cleaning equipment such as a soft pipe cleaner and soft cloth.
6. Dry part immediately after it is cleaned and rinsed.
7. Sanitize part with a clean cloth.
8. Repeat steps 4-7 for each remaining part until they are all clean.

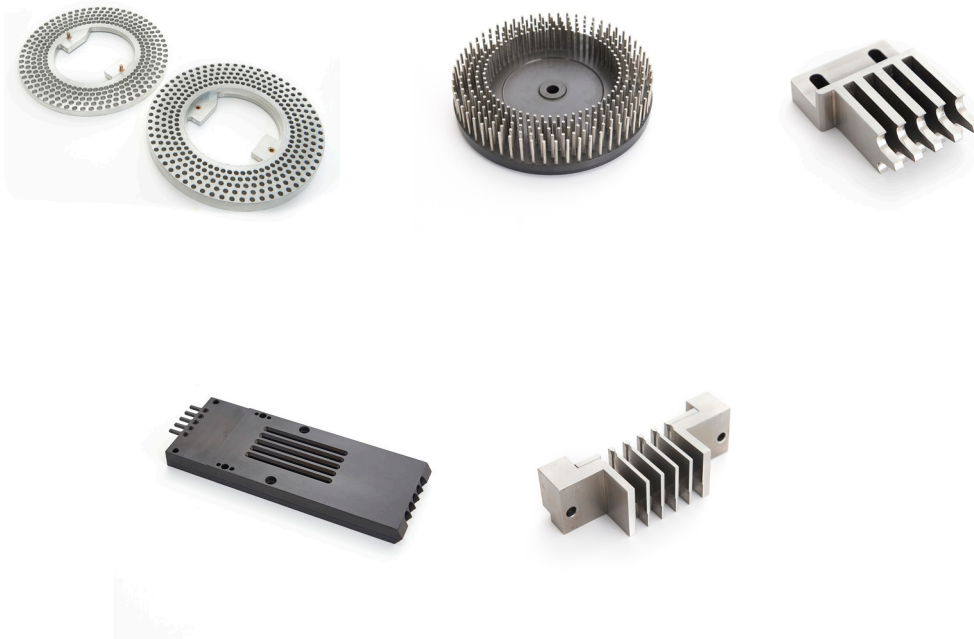

### Clean the Base

9. Spray the SACF 25<sup>®</sup> base with the cleaner, particularly in the location of the Tooling and Excess Powder Collector.



10. Rinse the cleaner off with potable water.
11. Sanitize the the SACF 25<sup>®</sup> base with a clean cloth.

## Cleaning Schedule Matrix

Part	After Installing Machine	After Every Use	Before Every Use	Inbetween Products That Present A Cross Contamination Risk	Weekly	Monthly	Before Placing In Storage	After Removing From Storage
Capsule Hopper	Wet clean and re-lubricate if specified in lubrication schedule	Dry clean and re-lubricate if specified in lubrication schedule	Dry clean and re-lubricate if specified in lubrication schedule	Wet clean and re-lubricate if specified in lubrication schedule	Dry clean and re-lubricate if specified in lubrication schedule	Wet clean and re-lubricate if specified in lubrication schedule	Dry clean and re-lubricate if specified in lubrication schedule	Wet clean and re-lubricate if specified in lubrication schedule
Powder Hopper	Wet clean and re-lubricate if specified in lubrication schedule	Wet clean and re-lubricate if specified in lubrication schedule	Wet clean and re-lubricate if specified in lubrication schedule	Wet clean and re-lubricate if specified in lubrication schedule	Wet clean and re-lubricate if specified in lubrication schedule	Wet clean and re-lubricate if specified in lubrication schedule	Wet clean and re-lubricate if specified in lubrication schedule	Wet clean and re-lubricate if specified in lubrication schedule
Base	Wet clean and re-lubricate if specified in lubrication schedule	Dry clean and re-lubricate if specified in lubrication schedule	Dry clean and re-lubricate if specified in lubrication schedule	Wet clean and re-lubricate if specified in lubrication schedule	Dry clean and re-lubricate if specified in lubrication schedule	Wet clean and re-lubricate if specified in lubrication schedule	Dry clean and re-lubricate if specified in lubrication schedule	Wet clean and re-lubricate if specified in lubrication schedule
Capsule Discs	Wet clean and re-lubricate if specified in lubrication schedule	Wet clean and re-lubricate if specified in lubrication schedule	Wet clean and re-lubricate if specified in lubrication schedule	Wet clean and re-lubricate if specified in lubrication schedule	Wet clean and re-lubricate if specified in lubrication schedule	Wet clean and re-lubricate if specified in lubrication schedule	Wet clean and re-lubricate if specified in lubrication schedule	Wet clean and re-lubricate if specified in lubrication schedule
Capsule Magazine and Teeth	Wet clean and re-lubricate if specified in lubrication schedule	Dry clean and re-lubricate if specified in lubrication schedule	Dry clean and re-lubricate if specified in lubrication schedule	Wet clean and re-lubricate if specified in lubrication schedule	Wet clean and re-lubricate if specified in lubrication schedule	Wet clean and re-lubricate if specified in lubrication schedule	Dry clean and re-lubricate if specified in lubrication schedule	Wet clean and re-lubricate if specified in lubrication schedule
Capsule Ejection Disc	Wet clean and re-lubricate if specified in lubrication schedule	Dry clean with cloth	Wet clean and re-lubricate if specified in lubrication schedule	Wet clean and re-lubricate if specified in lubrication schedule	Dry clean with cloth	Wet clean and re-lubricate if specified in lubrication schedule	Dry clean with cloth	Wet clean and re-lubricate if specified in lubrication schedule

### Cleaning Level Key

Level 1 - Remove powder
Level 2 - Dry clean with cloth
Level 3 - Dry clean and re-lubricate if specified in lubrication schedule
Level 4 - Wet clean and re-lubricate if specified in lubrication schedule
<b>Remove from machine</b> - Take part out of machine and clean if required. Store it correctly or install back into machine.
<b>Install into machine</b> - Install part into the machine and make sure that it has been cleaned. If needed, lubricate to the level required.
<b>Clean on/in machine</b> - Clean the part while in the machine and do not remove it. Make sure that all contact surfaces are clean to the level required.

This cleaning matrix is intended as a guide only and is not an exhaustive list. All cleaning schedules will need to be adapted to the industry and product, following industry regulations and the material safety data sheets that come with specific products. Please check with your Food Safety Manager/Department, Quality Control Manager/Department, or other relevant internal departments at your company before using.

# Storing the SACF

After its thorough cleaning, the SACF 25<sup>®</sup> needs to be stored in the proper conditions. It is important to store it in an environment in which the machine is safe from rusting. The SACF 25<sup>®</sup>'s high traction areas and the Tooling need to be lubricated separately before you store them.

## Tools and Materials Needed

- Plastic wrapping to cover machine
- Container(s) for Capsule Discs, Capsule Magazine, and Capsule Ejection Disc (if in storage for more than a week)
- Permanent marker
- Lubricant/grease (NSF approved lubricant if machine has a high chance of contact with the food or drug product)
- Disposable latex/rubber gloves (for food grade products and to protect hands from lubricant)
- Hairnet and/or beard net (food grade products only)
- Sterile shoe covers (food grade products only)

## Instructions

Note: Wear latex/rubber gloves (and appropriate food grade attire if applicable) during this process.

### Lubricating the Tooling

If you are not using the machine for more than a week, store the Tooling (Capsule Discs, Capsule Magazine, and Capsule Ejection Disc) in containers and cover it with lubricant to prevent rust formation. If not, simply lubricate each part of the Tooling and reinsert it back into the machine.

### Lubricating the Grease Points and High-Traction Parts

1. Remove the Capsule Hopper, the Powder Hopper, and the Capsule Magazine and teeth.
  - 1.1 Note: Please refer to the remove and replace Tooling instructions on page 42 for further assistance.
2. Trace the washers on the mounting block with a permanent marker.
  - 2.1 Note: This is to mark the correct position of the bolts and washers in the mounting block for reinsertion.



3. Remove the mounting block from the machine by loosening its bolts with an Allen key.
4. Remove each of the four panels that enclose the Capsule Sewing Mechanism with an Allen key.



5. Apply grease to each of the bearings inside the Capsule Sewing Mechanism.



6. Remove the two door panels located in the back of the machine.
7. Apply oil to the Gearbox above the machine's electrics.

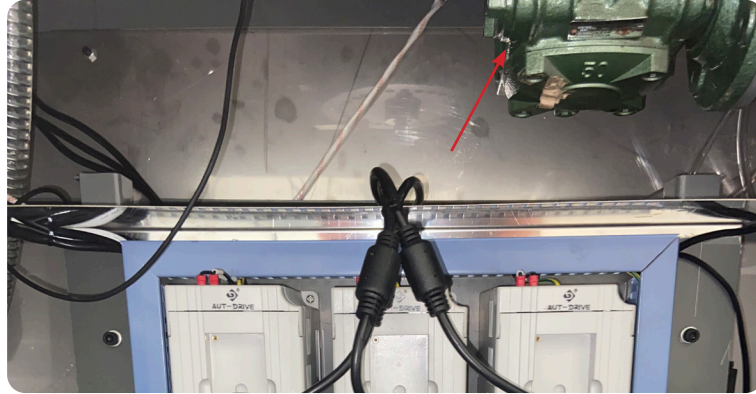

### Environmental Conditions

It is important that the environment in which you store the SACF 25<sup>®</sup> has the appropriate temperature and relative humidity levels. These two environmental factors can potentially cause the machine to rust and/or cause the capsules to have a lower quality. The table below shows the acceptable temperature and relative humidity levels:

Machine	Temperature		Humidity
	°C	°F	
SACF 25 <sup>®</sup>	18-24	64-75	45-55% RH

# Appendix

## Glossary

Term	Definition
API/Active Pharmaceutical Ingredient	Any substance or mixture of substances used that is an active ingredient in the drug product.
Capsule Ejection Disc	Disc that contains pins to seal and eject capsules when the Capsule Discs are pushed against it.
Capsule Discs	Discs that contain the capsule caps and bodies halves.
Capsule Magazine	The unit in which the capsules are inserted and oriented. It also feeds the capsule halves into the Capsule Discs.
Capsule Sealer	Area of machine in which the capsules are sealed inside of the Capsule Discs.
Capsule Sewing Mechanism	Area of machine in which the capsules are oriented and fed into the Capsule Discs.
Excipient	An inactive substance that serves as the vehicle or medium for a drug or other API.
Formulation	Powder mix of the excipient and the API that is used to fill capsules.
Megapascal (MPa)	The measure of force per unit area and defined as one newton per square meter.
Tooling	Enables a semi-automatic capsule filler to fill and seal capsules. It consists of Capsule Discs, a Capsule Magazine, and a Capsule Ejection Disc.

## Description of SACF 25<sup>®</sup> Parts

### **Filter Bag for Capsule Filler Vacuum Pump**

The Filter Bag for the Capsule Filler Vacuum Pump catches dust and debris that come from the machine's operation. Order at <https://www.lfacapsulefillers.com/filer-bag-capsule-filler-vacuum-pump>

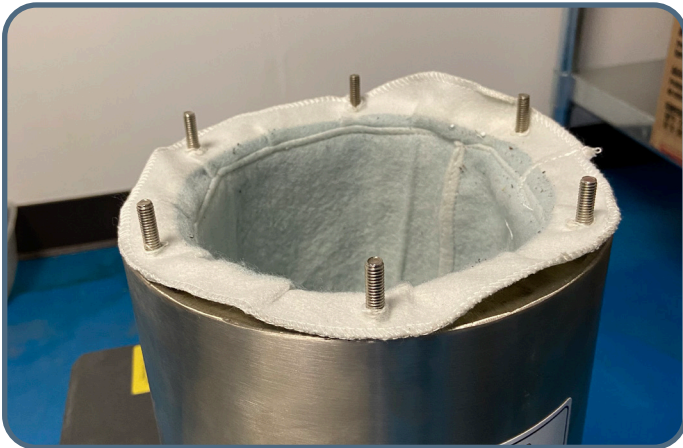

### **Spare Capsule Discs**

The Spare Capsule Discs, along with the Capsule Discs that come with the machine, enable the operator to insert capsules and fill simultaneously. Order at <https://www.lfacapsulefillers.com/sacf-25-spare-plates>



### **Tooling**

The Tooling consists of the Capsule Discs, the Capsule Ejection Disc, and the Capsule Magazine. They all work as a set to fill the powder into capsules. Order at <https://www.lfacapsulefillers.com/sacf25-plates-moulds-set>



### **Capsule Filler Vacuum Pump**

The Capsule Filler Vacuum Pump works with the Capsule Sewing Mechanism. Order at <https://www.lfacapsulefillers.com/capsule-filler-vacuum-pump>



### **Teflon Wear Part on Vacuum Section**

This wear part sits between the vacuum section and on the main body of the machine and the Capsule Discs when the capsules are being sewn and maintains a seal between the disc and the vacuum. Order at <https://www.lfacapsulefillers.com/teflond-wear-part-vacuum-sacf-25>



### **Teflon Wear Part on Bottom of Auger**

This wear part sits between the Powder Hopper with its auger and the Capsule Disc that holds the capsule bodies that are being filled and maintains a seal between the plate and the auger. Order at <https://www.lfacapsulefillers.com/teflon-wear-part-auger-sacf-25>





## Food Grade Point of Contact Parts

Contact Part	Material
Capsule Discs	LY12 aluminum alloy
Capsule Ejection Disc	LY12 aluminum alloy and SUS304
Powder Hopper	SUS304
Capsule Hopper	SUS304
Alignment Tools	SUS304

## Technical Specifications

Maximum output	up to 25,000/hr (#2 size)
Compatible capsule sizes	#00L, #00, #0, #1, #2, #3, #4, #5
Filling precision	+/-3%
Decibels	≤ 60 dB
Weight	330 kg/727.5 lbs
Power USA	240 V/3 phase/4 kW/60 Hz
Power UK	440 V/3 phase/4 kw/ 50 Hz
Vacuum pump	40 m <sup>3</sup> /h
Capacity of air compressor	0.1 m <sup>3</sup> /min
Overall size	1200 mm x 700 mm x 1600 mm
Dimensions with suggested working clearance	2100 mm x 1600 mm x 2500 mm
Floor loading	3.62 kN/m <sup>2</sup>

## Bores per Capsule Disc

Capsule Disc Size	Number of Bores	Maximum Output per hour
#00	300	17,850
#0	360	21,400
#1	360	21,400
#2	420	25,000
#3	420	25,000
#4	420	25,000
#5	420	25,000

## Maintenance Checklist

<b>Before Operation</b>	
<input type="checkbox"/>	Visually inspect the semi-automatic capsule filler and the parts.
<input type="checkbox"/>	Ensure all nuts and bolts are tight.
<input type="checkbox"/>	Visually inspect grease points and regrease where necessary.
<input type="checkbox"/>	Run the machine at a slow speed to ensure that everything is operating correctly.
<input type="checkbox"/>	Visually inspect electrical wires for any damage.
<b>During Operation</b>	
<input type="checkbox"/>	Tune the semi-automatic capsule filler until the capsule fill and weight are correct.
<input type="checkbox"/>	Listen for irregular knocking or clicking sounds. If heard, stop operation, dislodge any stuck capsules from the machine, adjust the Capsule Holding Pins, and lubricate the machine.
<input type="checkbox"/>	Watch for buildup of powder on the Auger inside the Powder Hopper. If occurring, either (a) make mix more granular, (b) check the Auger for damage, or (c) clear the buildup.
<input type="checkbox"/>	Occasionally check the Motor's temperature. If it starts to overheat, turn off the machine, let it cool down, and grease it to ensure smooth operation.
<input type="checkbox"/>	Ensure that the Hoppers do not run out of powder and capsules.
<input type="checkbox"/>	Weigh five or ten sample capsules to ensure the desired weight and fill are being met.
<input type="checkbox"/>	Check to see that the Emergency Stop properly works.
<b>After Operation</b>	
<input type="checkbox"/>	Unplug machine and remove all excess powder with a bagless vacuum.
<input type="checkbox"/>	Clean the Capsule Hopper, the Powder Hopper, the Capsule Magazine and teeth, the Capsule Discs, the Capsule Ejection Disc, and the Auger.
<input type="checkbox"/>	Wipe down the other surfaces with a damp cloth.
<input type="checkbox"/>	Lubricate all grease points.
<input type="checkbox"/>	Store Tooling in a container with a small amount of grease.

# Diagrams

## SACF 25<sup>®</sup> Tooling Dimensions

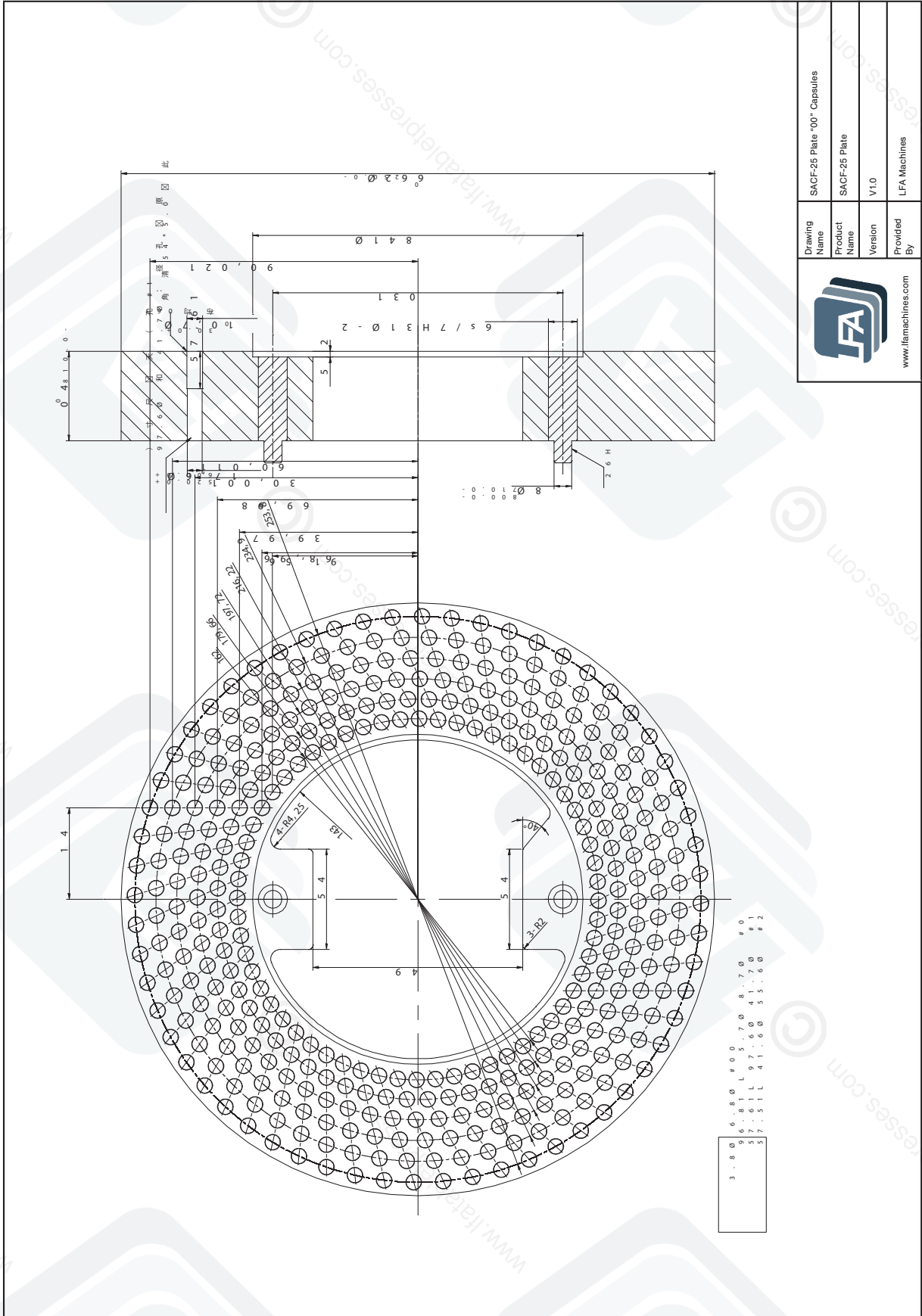

# SACF 25<sup>®</sup> Air Drawing

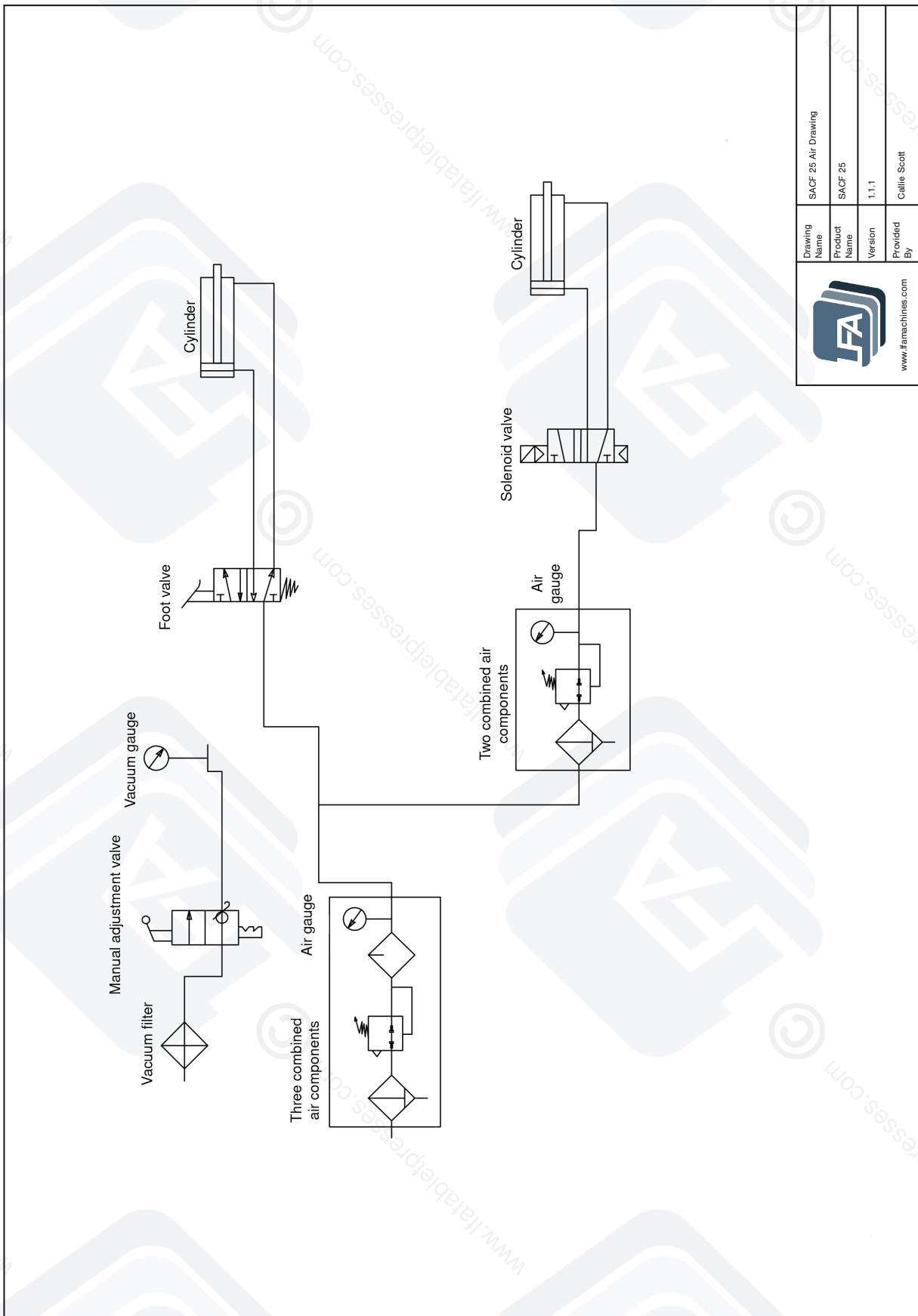



Drawing Name	SACF 25 Air Drawing
Product Name	SACF 25
Version	1.1.1
Provided By	Callie Scott

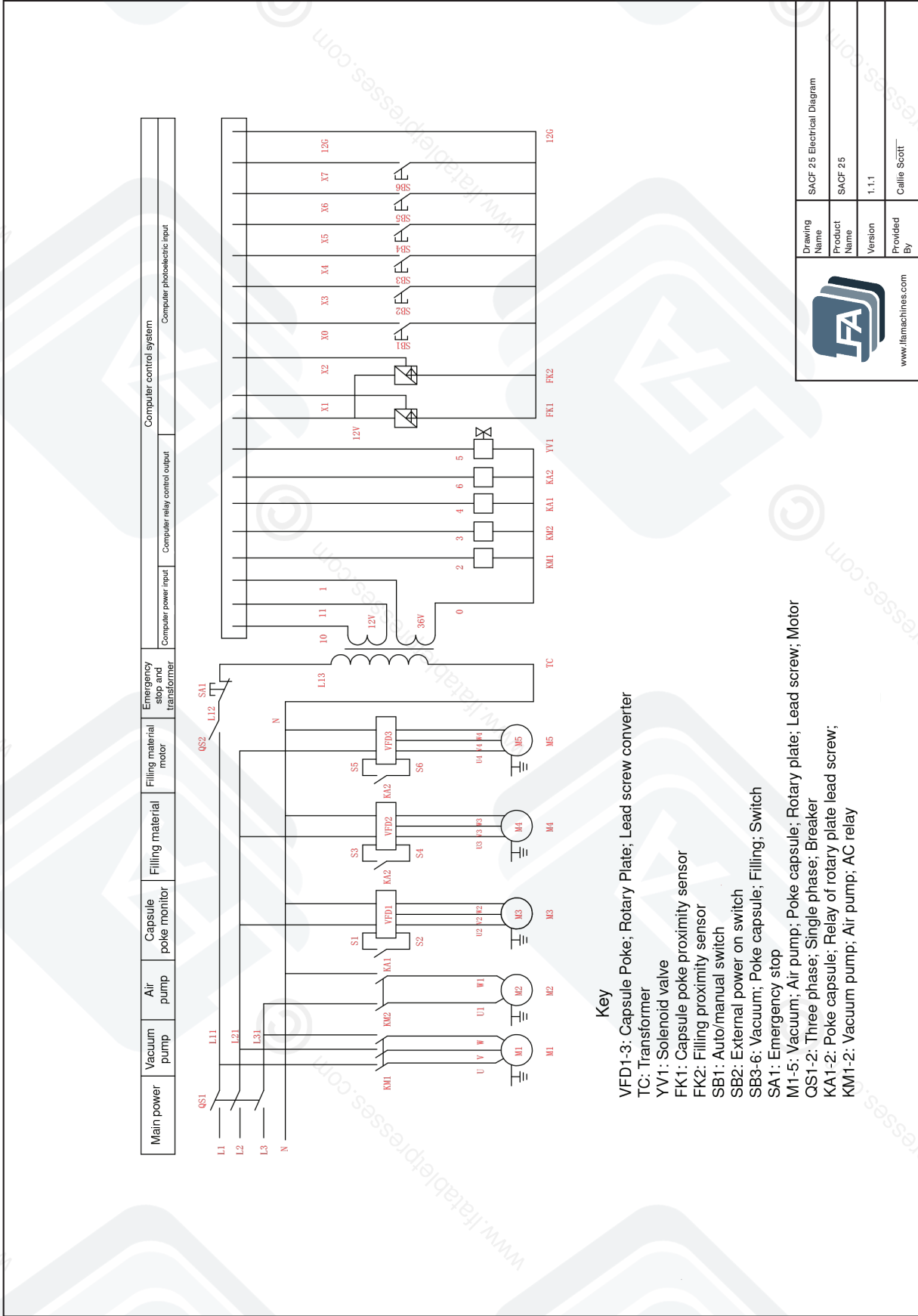

www.jfamachines.com

# SACF 25® Wiring Diagram



 www.lfamachines.com	Drawing Name	SACF 25 Electrical Diagram
	Product Name	SACF 25
	Version	1.1.1
Provided By	Callie Scott	

# SACF 25® Floor Plan

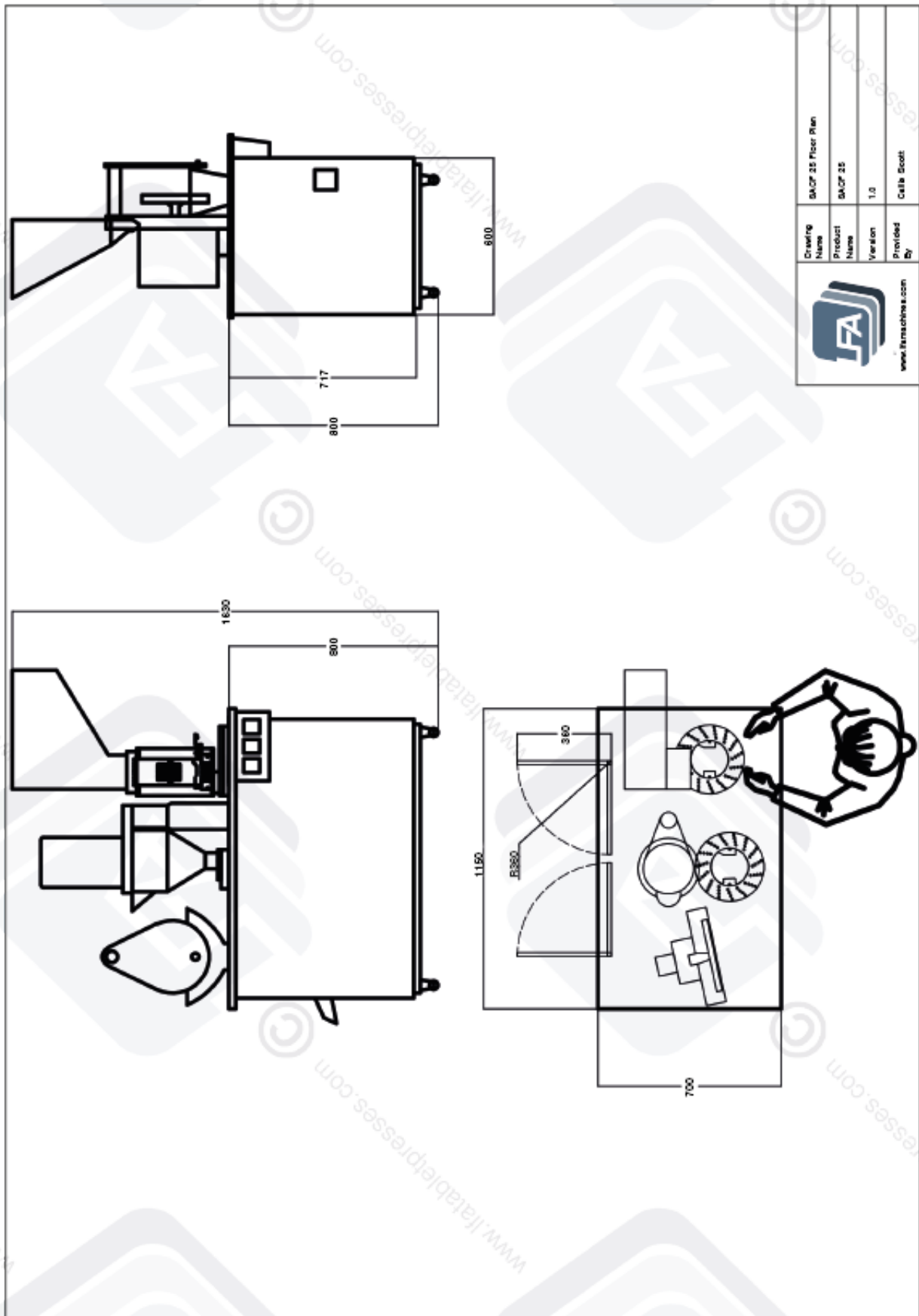

# Resources

## Helpful Links

### Warranty

For information regarding the warranty policy of the SACF 25<sup>®</sup> and other LFA products, please visit <https://www.lfacapsulefillers.com/warranty>

### LFA Website

In order to aid you in your capsule production, LFA Machines maintains a website that offers a breadth of useful information about the SACF 25<sup>®</sup> and other capsule fillers. You also have access to online tools such as the Capsule Size Chart and our regularly published articles that cover a whole range of topics about semi-automatic capsule fillers and capsule production.

Visit the LFA homepage at <https://www.lfacapsulefillers.com>

To create a free member's account, follow this link: <https://www.lfacapsulefillers.com/customer/account/create>

### LFA Machines YouTube Channel

Our YouTube videos provide you an opportunity to see demonstrations of how to use our semi-automatic capsule fillers, common troubleshooting tips, and other LFA capsule fillers and mixers. We regularly upload videos to give you a visual aid that will hopefully support you in your capsule production efforts. To watch our videos, visit <https://www.youtube.com/channel/UCwtbcwja77ai7vX2o34FUkQ>

### LFA Machines Social Media

Social media is a great way to keep yourself updated on new developments and exciting things happening at LFA Machines. The list below contains our current social media pages:

Twitter: @lfatabletpress

Instagram: @lfatabletpresses

Facebook: <https://www.facebook.com/lfatabletpresses>

LinkedIn: <https://www.linkedin.com/company/lfa-machines-oxford-ltd/>

## Contact Us

### UK

LFA Machines Oxford Ltd  
Unit 4B Rowood Estate  
Murdock Road  
Bicester, Oxfordshire OX26 4PP  
+44 01869 250234  
[support.uk@lfamachines.com](mailto:support.uk@lfamachines.com)  
Monday-Friday  
9AM-5PM GMT

### USA

LFA Machines DFW, LLC  
6011 Will Rogers Blvd  
Fort Worth, TX 76140  
+1 (682) 312 0034  
[support.usa@lfamachines.com](mailto:support.usa@lfamachines.com)  
Monday-Friday  
8AM-6PM UTC (Central)

### Germany

LFA Machines Düsseldorf GmbH  
Business Parc Am Trippelsberg 92  
Düsseldorf, North-Rhine  
Westphalia 40589  
+41 21188250223  
[verkauf@lfamachines.com](mailto:verkauf@lfamachines.com)

### Taiwan

LFA Machines Taiwan Ltd  
7F-5, No. 2, Sec. 2 Taiwan Blvd  
West District, Taichung City 403  
Taiwan  
+886 422031790  
[support.asia@lfamachines.com](mailto:support.asia@lfamachines.com)  
Monday-Friday  
9AM-5PM GMT+8



LFA MACHINES

Copyright © 2025 by LFA Machines

[www.lfamachines.com](http://www.lfamachines.com)

**United Kingdom**

Unit 4B  
Murdock Road  
Bicester  
Oxfordshire  
United Kingdom  
OX26 4PP

**United States**

6601 Will Rogers Blvd  
Fort Worth  
Texas  
United States  
76140

**Germany**

Business Parc Am  
Trippelsberg 92  
Düsseldorf  
Germany  
40589

**Taiwan**

7F.-5, No. 2, Sec. 2  
Taiwan Blvd., West Dist.,  
Taichung City 403,  
Taiwan